

<b>Label:</b> <b>LINDBERGH</b>	<b>Date: 24/03/2023</b> <b>Modification date:</b> <b>13 November 2025 11:36 am</b>	
<b>Description:</b> Label instruction for 2-pack tank top	<b>Labels instruc. No.:</b> LBA-9700	<b>Design:</b> AKR/MKS

**Box for tank top. LBA-716** (same as box LBA-708 with new artwork)

**Colours :**

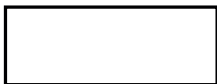
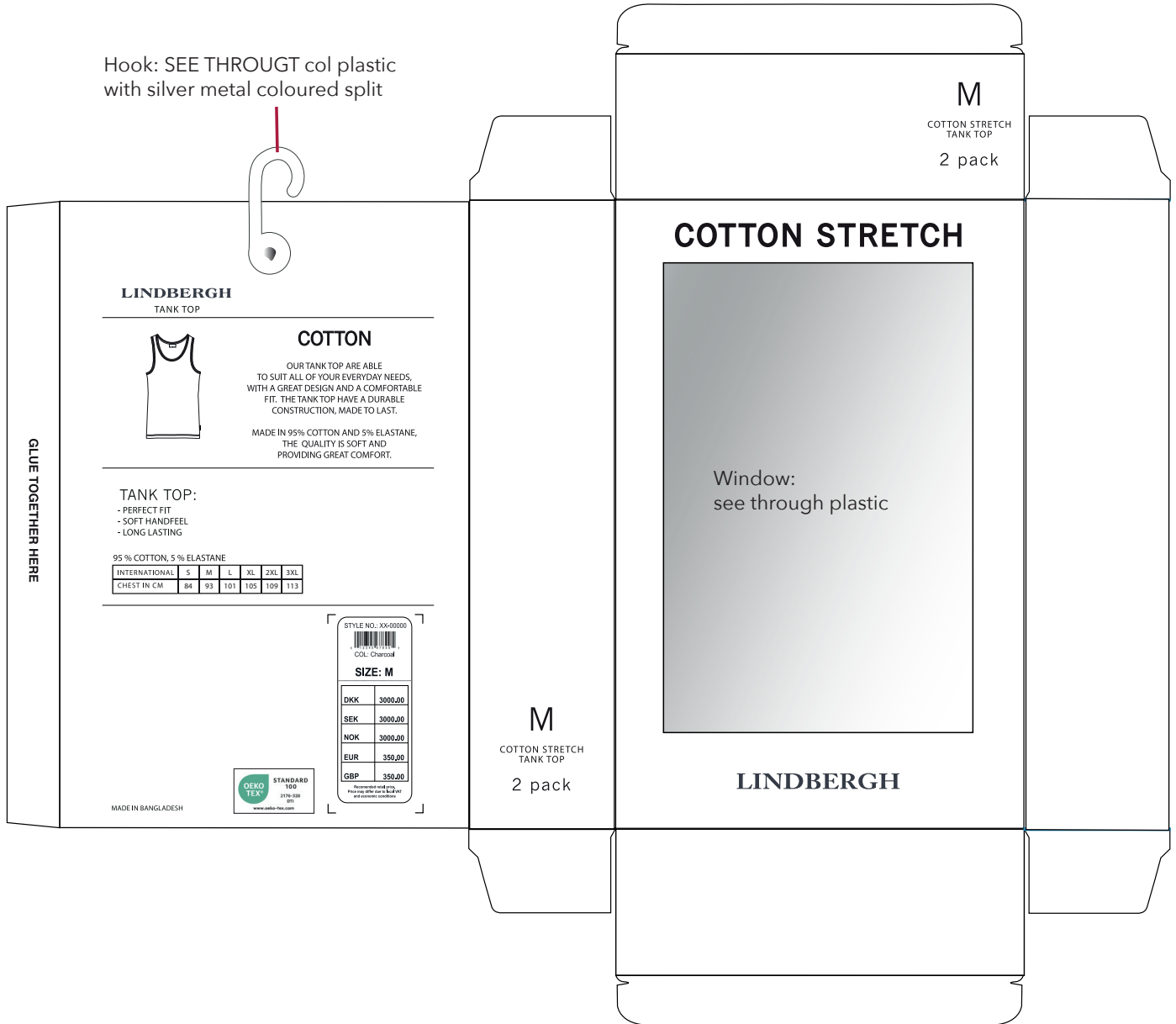

Main box col.: Brilliant white 14-4001 TCX



Text col.: Black beauty 19-3911 TCX

<b>Label:</b> <b>LINDBERGH</b>	<b>Date:</b> 24/03/2023 <b>Modification date:</b> 13 November 2025 11:36 am	
<b>Description:</b> Label instruction for 2-pack tank top	<b>Labels instruc. No.:</b> LBA-9700	<b>Design:</b> AKR/MKS

## Folding Instruction:

BELOW DRAWING IS NOT TO SCALE

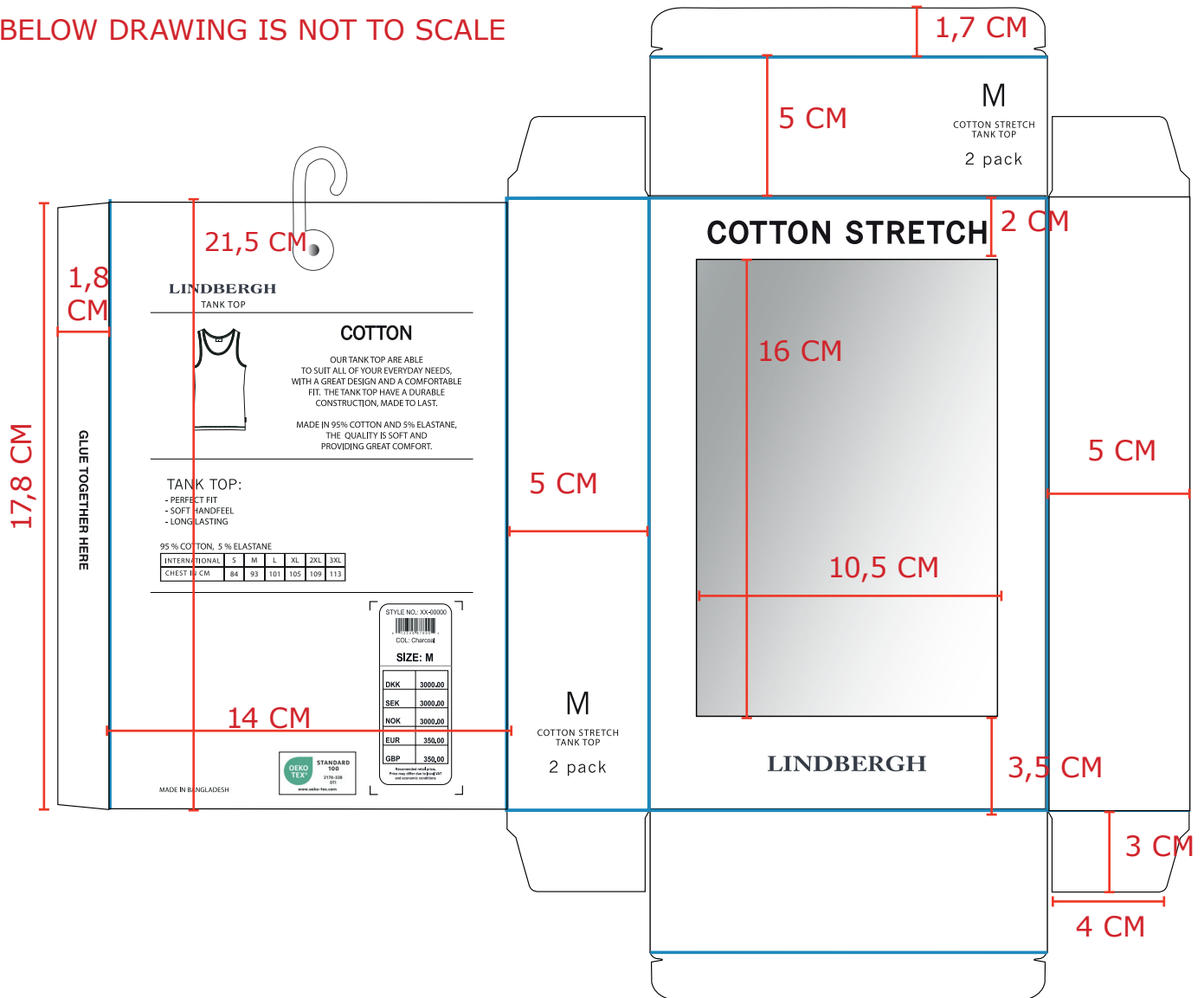

— Folding lines

○ Box material

● See through plastic

<b>Label:</b> <b>LINDBERGH</b>	<b>Date:</b> 24/03/2023 <b>Modification date:</b> 13 November 2025 11:36 am	
<b>Description:</b> Label instruction for 2-pack tank top	<b>Labels instruc. No.:</b> LBA-9700	<b>Design:</b> AKR/MKS

**Print placement:** - Please use org. print file but change size on box accordingly

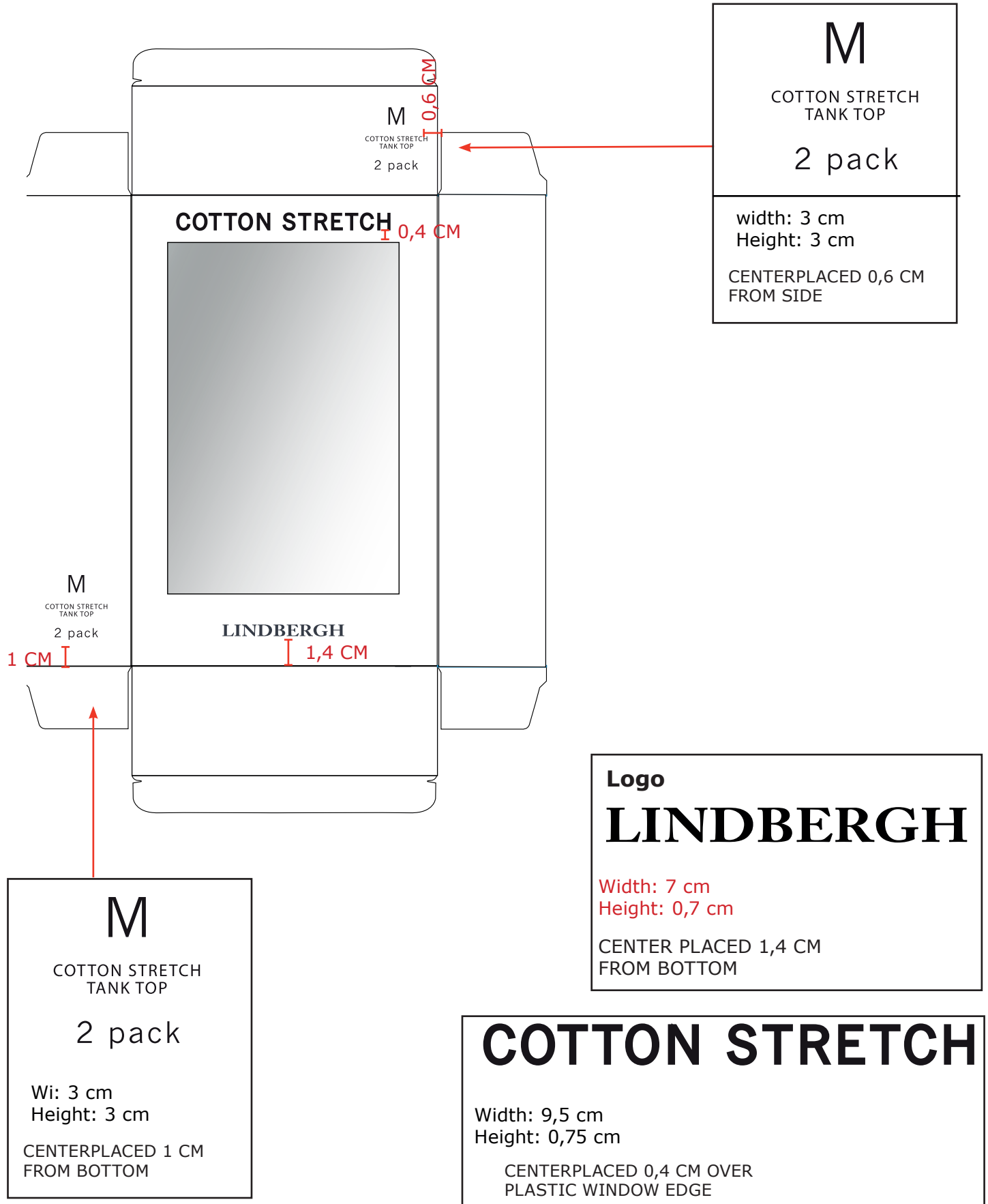

<b>Label:</b> <b>LINDBERGH</b>	<b>Date:</b> 05/02/2020 <b>Modification date:</b> 13 November 2025 11:36 am	
<b>Description:</b> Label instruction for 2-pack tank top	<b>Labels instruc. No.:</b> LBA-9700	<b>Design:</b> AKR

## Print for Back + closure

**- Please use org. print file but change Size on box accordingly**

### Back print:

CENTERPLACED 7,5 CM FROM BOTTOM

Width: 11,4 cm

Height: 11 cm

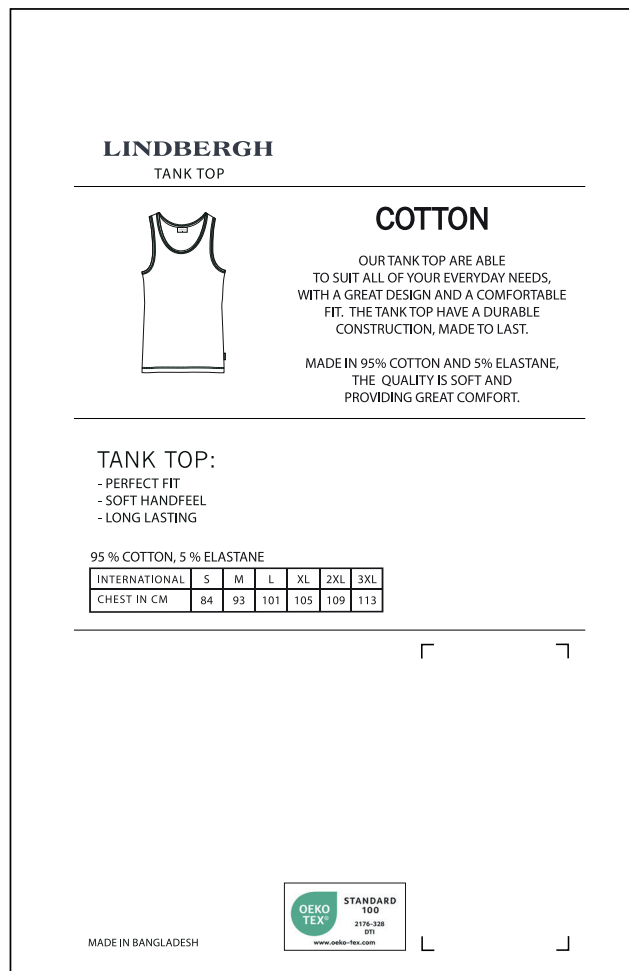
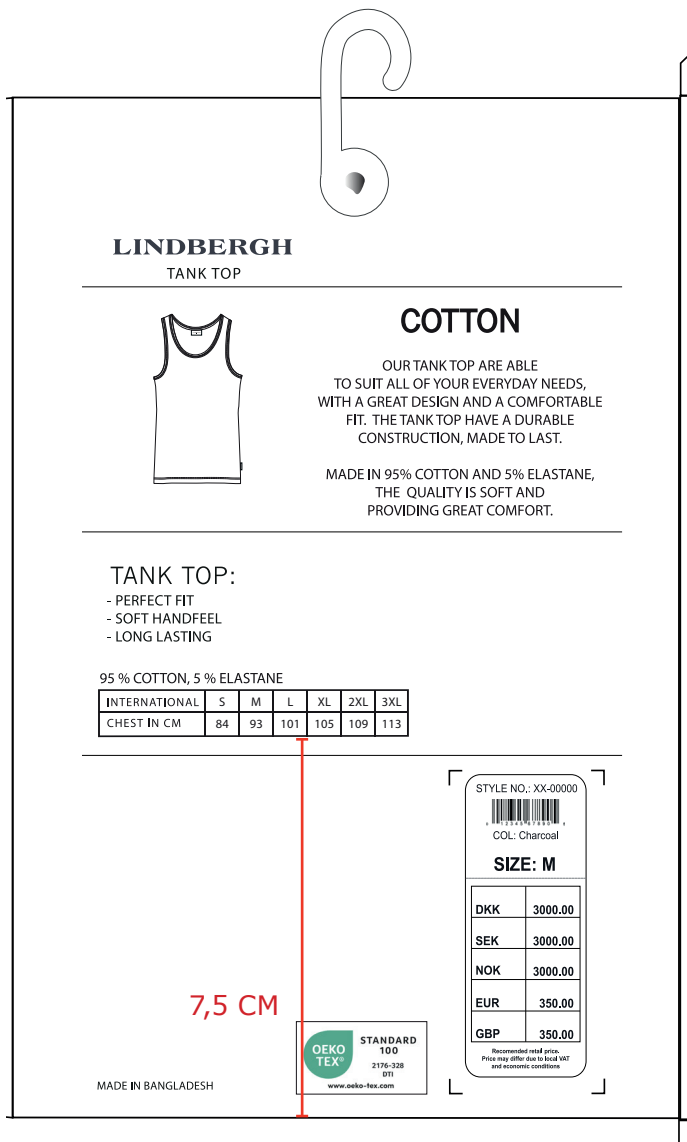

CENTERPLACED 7,5 CM FROM BOTTOM

<b>Label:</b> <h1>LINDBERGH</h1>	<b>Date:</b> 24/03/2023 <b>Modification date:</b> 13 November 2025 11:36 am	
<b>Description:</b> Label instruction for 2-pack tank top	<b>Labels instruc. No.:</b> LBA-9700	<b>Design:</b> AKR/MKS

### STICKER for salesmand sample



Follow instruction no. :  
007 salesman sticker

### BARCODE for Production

Barcode Placement (for production Only)  
Place price Sticker at fixing Points.

STYLE NO.: XX-00000

COL: Charcoal

**SIZE: M**

DKK	3000.00
SEK	3000.00
NOK	3000.00
EUR	350.00
GBP	350.00

Recommended retail price. Price may differ due to local VAT and economic conditions

### Oekotex print logo:



### Oeko-tex logo color ref:

Label Design Guideline Colour Values			
	OEKO-TEX® Green	Black	White
<b>PRINT</b>			
Pantone U	Green U	Black U	-
Pantone C	Green C	Black C	-
CMYK	c84-m0-y57-k0	c0-m0-y0-k98	c0-m0-y0-k0
RAL DESIGN	170 60 45	000 30 00	000 90 00
<b>DIGITAL</b>			
RGB	r0-g166-b135	r5-g0-b5	r255-g255-b255
HEX	#00A0C0	#000000	#FFFFFF

### Label Design Guideline Safe Zone + Placement

Please note:  
Minimum safe zone 'X' is the size of the 'X' in the OEKO-TEX® Logo.

<b>Label:</b> <b>LINDBERGH</b>	<b>Date:</b> 24/03/2023 <b>Modification date:</b> 13 November 2025 11:36 am	
<b>Description:</b> Label instruction for 2-pack tank top	<b>Labels instruc. No.:</b> LBA-9700	<b>Design:</b> AKR/MKS

**S**

COTTON STRETCH  
TANK TOP

2 pack

**Print for size :**

**- Please use org. print file but change size on box accordingly**

**M**

COTTO STRETCH  
TANK TOP

2 pack

**L**

COTTON STRETCH  
TANK TOP

2 pack

**XL**

COTTON STRETCH  
TANK TOP

2 pack

**2XL**

COTTON STRETCH  
TANK TOP

2 pack

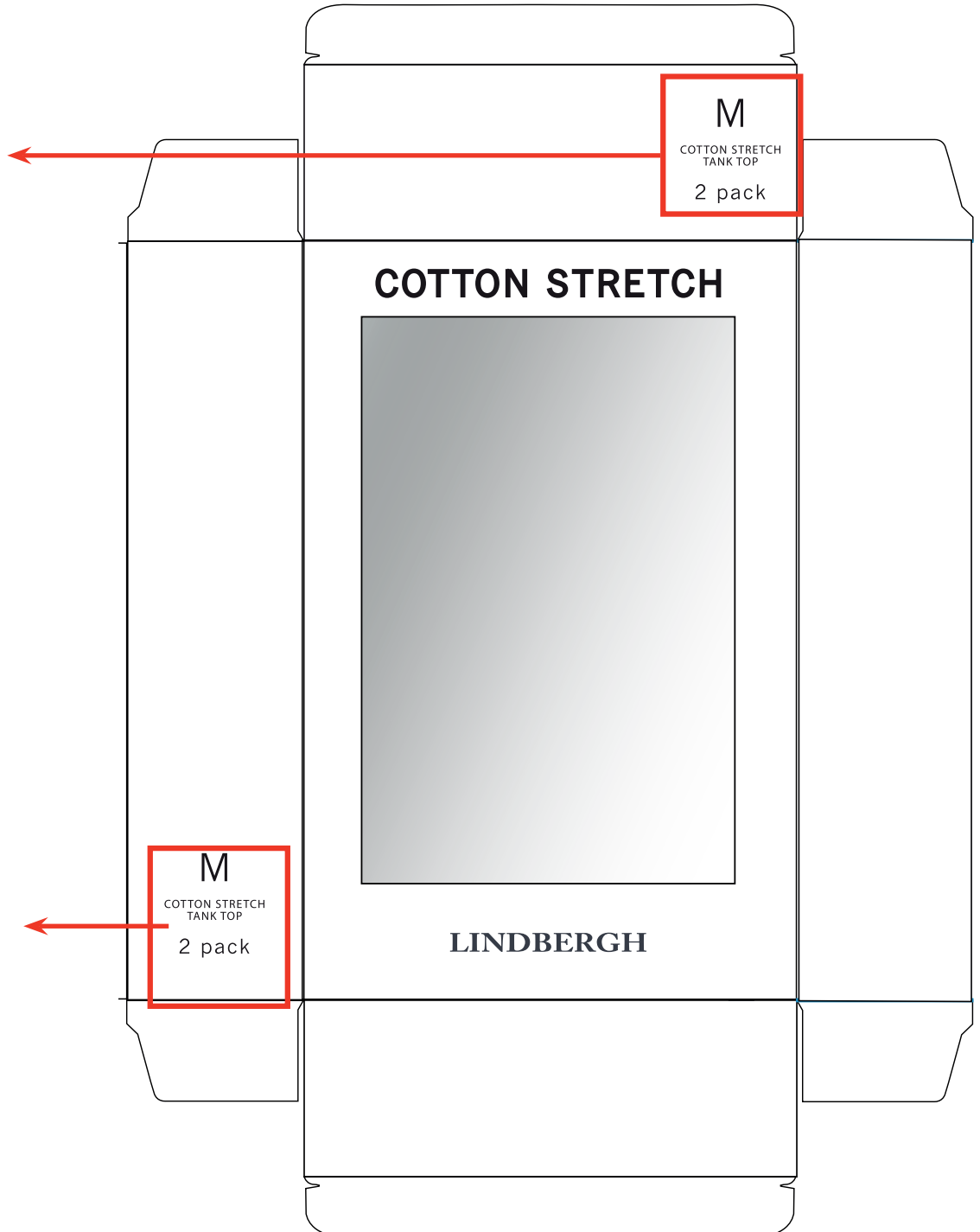

<b>Label:</b> <b>LINDBERGH</b>	<b>Date:</b> 24/03/2023 <b>Modification date:</b> 13 November 2025 11:36 am	
<b>Description:</b> Label instruction for 2-pack tank top	<b>Labels instruc. No.:</b> LBA-9700	<b>Design:</b> AKR/MKS

**Plastic hook with metal split**

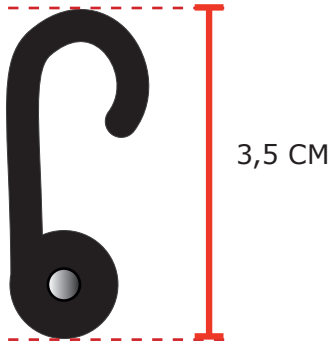

centered on box

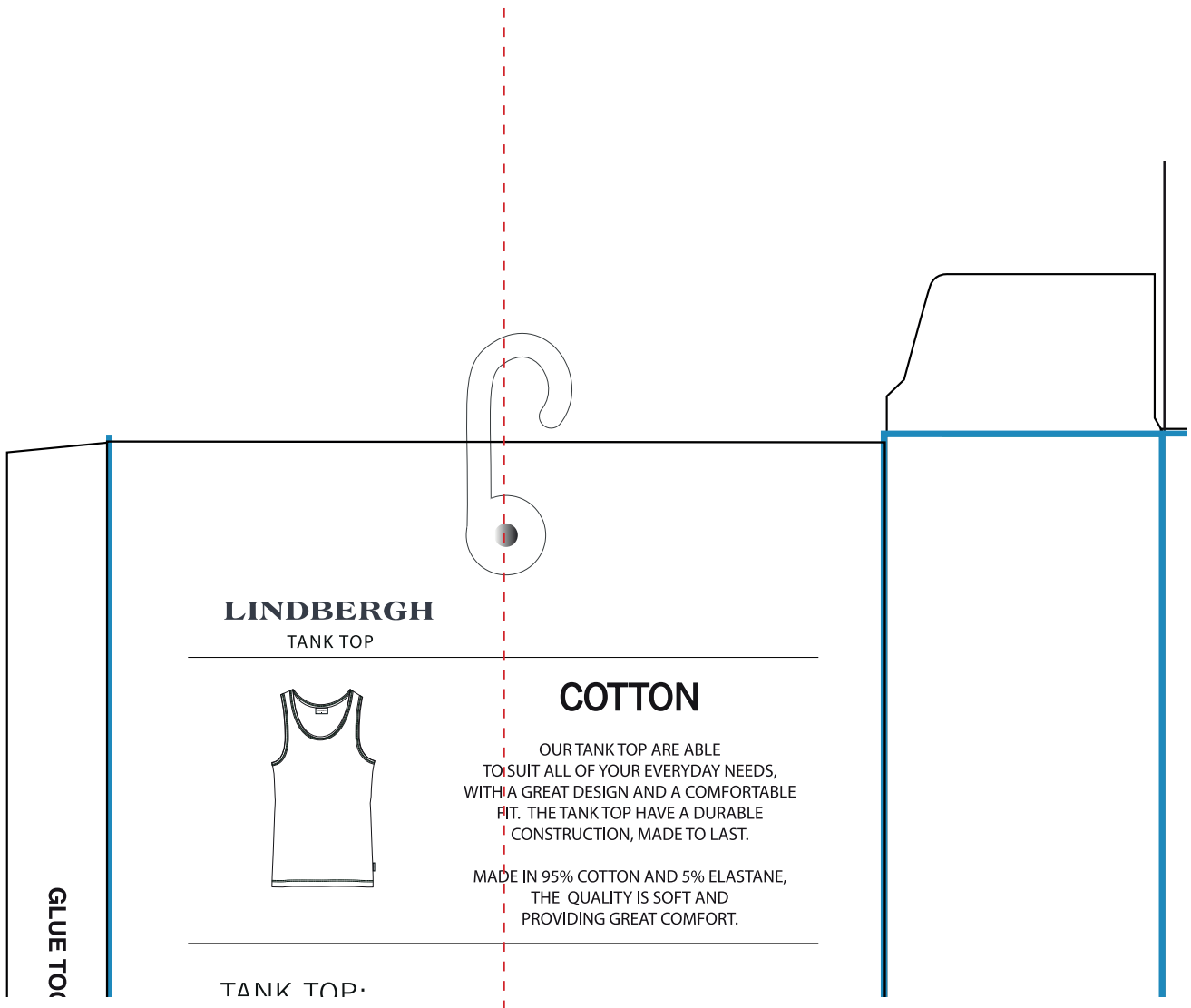

<b>Label:</b> <b>LINDBERGH</b>	<b>Date:</b> 24/03/2023 <b>Modification date:</b> 13 November 2025 11:36 am	
<b>Description:</b> Label instruction for 2-pack tank top	<b>Labels instruc. No.:</b> LBA-9700	<b>Design:</b> AKR/MKS

**Label instructions:**

Find correct RN and CA number in supplier manual under packing and labeling → special orders. Please center text, when correct number is added.

**Made in sticker**  
Ref. no.: PWT-102 (lindbergh)

MADE IN XXXXXX  
FABRIQUE EN XXXXXX

**Placement:**  
Please see separate instruction.

PLEASE PLACE SIDESEAM AT RIGHT SIDE

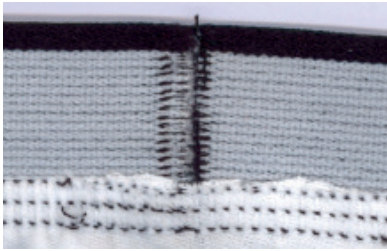

**Elasticated waistband inside, with printed size label and carelabel**

**Small**

STYLE: XX-XXXXX  
ORDER: XXXXXXXXX

RN no. XXXX  
CA no. XXXX

WASH WITH SIMILAR COLOURS  
MAX SHRINKAGE 5%.

47,5% MODAL  
42,5% COTTON  
10% ELASTANE

**Medium**

STYLE: XX-XXXXX  
ORDER: XXXXXXXXX

RN no. XXXX  
CA no. XXXX

WASH WITH SIMILAR COLOURS  
MAX SHRINKAGE 5%.

47,5% MODAL  
42,5% COTTON  
10% ELASTANE

**Large**

STYLE: XX-XXXXX  
ORDER: XXXXXXXXX

RN no. XXXX  
CA no. XXXX

WASH WITH SIMILAR COLOURS  
MAX SHRINKAGE 5%.

47,5% MODAL  
42,5% COTTON  
10% ELASTANE

**X Large**

STYLE: XX-XXXXX  
ORDER: XXXXXXXXX

RN no. XXXX  
CA no. XXXX

WASH WITH SIMILAR COLOURS  
MAX SHRINKAGE 5%.

47,5% MODAL  
42,5% COTTON  
10% ELASTANE

**2X Large**

STYLE: XX-XXXXX  
ORDER: XXXXXXXXX

RN no. XXXX  
CA no. XXXX

WASH WITH SIMILAR COLOURS  
MAX SHRINKAGE 5%.

47,5% MODAL  
42,5% COTTON  
10% ELASTANE

**3X Large**

STYLE: XX-XXXXX  
ORDER: XXXXXXXXX

RN no. XXXX  
CA no. XXXX

WASH WITH SIMILAR COLOURS  
MAX SHRINKAGE 5%.

47,5% MODAL  
42,5% COTTON  
10% ELASTANE

**Medium**

STYLE: XX-XXXXX  
ORDER: XXXXXXXXX

RN no. XXXX  
CA no. XXXX

WASH WITH SIMILAR COLOURS  
MAX SHRINKAGE 5%.

5% LYCRA  
95% COTTON

**PLEASE FILL IN CORRECT QUALITY**

Size label font	Arial Bold
Size label fontsize	14
Carelabel font	Arial
Carelabel fontsize	9
Print colour on light fabrics	Lt grey 15-4101 TCX
Print colour on dark fabrics	White

<b>Label:</b> <b>LINDBERGH</b>	<b>Date:</b> 24/03/2023 <b>Modification date:</b> 13 November 2025 11:36 am	
<b>Description:</b> Label instruction for 2-pack tank top	<b>Labels instruc. No.:</b> LBA-9700	<b>Design:</b> AKR/MKS

**Box when folded**

