

<b>Label:</b> <b>LINDBERGH</b>	<b>Description :</b> LINDBERGH WHITE - SHIRTS - all fit + sizes	<b>Date:</b> 04/08/20 <b>Modification date:</b> 9 February 2026 8:35 am
	<b>Label instruction no:</b> LBH-W-2002	<b>Design :</b> <b>AKR</b>

HANGTAG LBH-W-931:

**Tag placement**

Hangtag must be fixed with knot at 2nd button hole. See sketch below

FRONT:

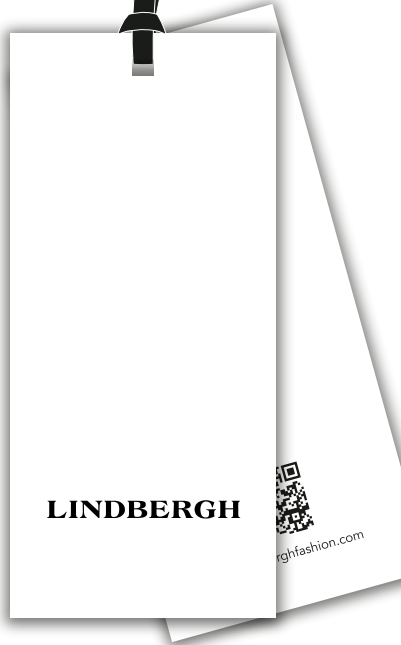

BACK:

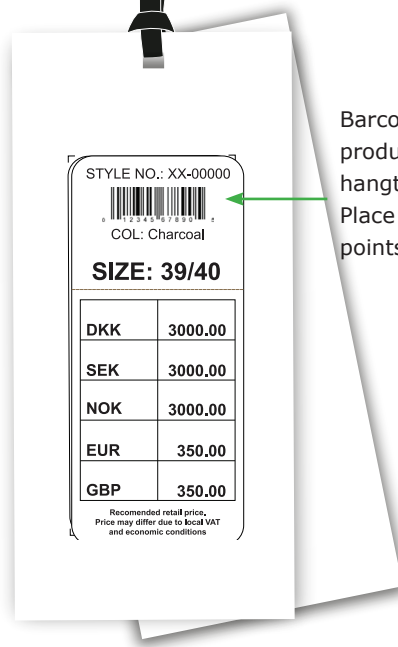

Barcode placement (for production only) inside hangtag.  
Place price sticker at fixing points.

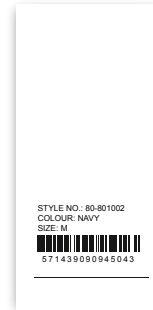
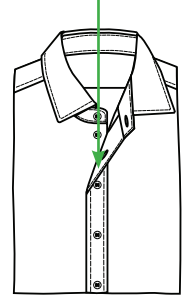

Follow instruction no. : 007 salesman sticker

<b>Label:</b> <b>LINDBERGH</b>	<b>Description :</b> LINDBERGH WHITE - SHIRTS - all fit + sizes	<b>Date:</b> 04/08/20 <b>Modification date:</b> 9 February 2026 8:35 am
	<b>Label instrution no:</b> LBH-W-2002	<b>Design :</b> AKR

LABEL LBH-W-838



**PLACEMENT:**

Size label:  
Please place 6 cm from C.B at collar stand.

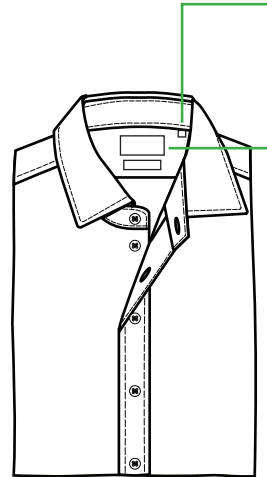

Neck label must be placed 1,5 cm below collar stand. Stitch only both sides (open top/bottom)

PLEASE CHECK MEASUREMENT CHART FOR KIND OF FIT LABEL

SIZE LABEL:

SIZE LABEL LBH-W-841

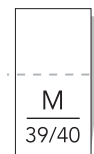

PLEASE CHECK MEASUREMENT CHART FOR KIND OF SIZE LABEL

<b>Label:</b> <b>LINDBERGH</b>	<b>Description :</b> LINDBERGH WHITE - SHIRTS - all fit + sizes	<b>Date:</b> 04/08/20 <b>Modification date:</b> 9 February 2026 8:35 am
	<b>Label instruction no:</b> LBH-W-2002	<b>Design :</b> AKR

**STORYTELLING LABEL:**



See program  
For label number

**PLACEMENT :**

Below main label  
= 1 cm  
Stitch both sides.  
Col. match label colour

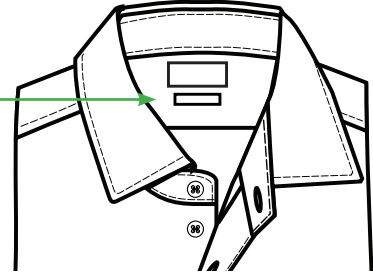

**2 STORYTELLING LABELS:**



See program  
For label number

**PLACEMENT :**

Distance between  
the storytelling  
labels is 1 cm  
Stitch both sides.  
Col. match label colour

Storytelling label 1  
Storytelling label 2

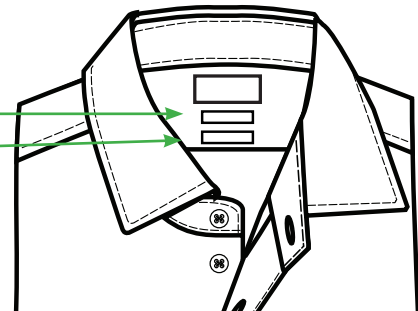

<b>Label:</b> <b>LINDBERGH</b>	<b>Description :</b> LINDBERGH WHITE - SHIRTS - all fit + sizes	<b>Date:</b> 04/08/20 <b>Modification date:</b> 9 February 2026 8:35 am
	<b>Label instruction no:</b> LBH-W-2002	<b>Design :</b> AKR

## Folding and packing instruction

Folded and packed:  
Width: 21 cm  
Height: 36 cm

**L/S:**

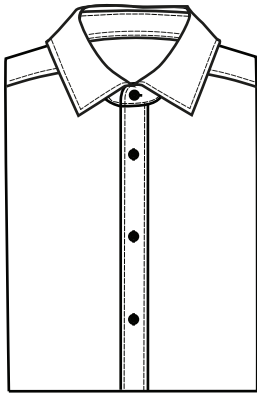

No metal needle  
in the shirt

**S/S:**

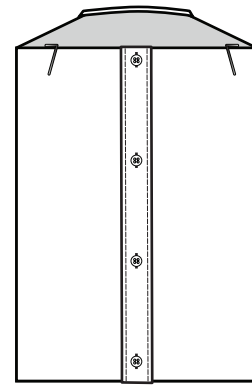
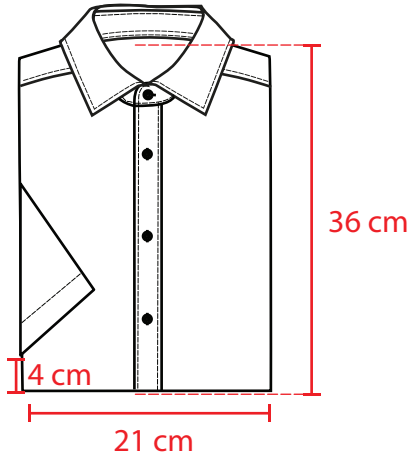

Please use plastic clips  
to fix the shirt

### Cardboard

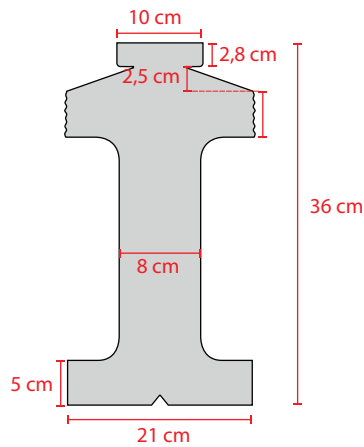
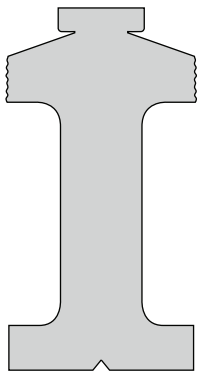

### Tissue paper

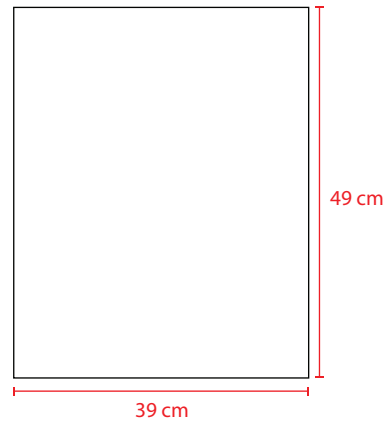

4 layers of  
tissue paper

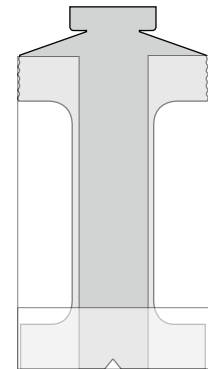

Tissue paper  
placed and folded as  
sketch

### Plastic collar stand

(inside collar)



### Plastic butterfly

(for shirts with fixed collar)

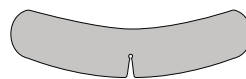

Single butterfly to fix collar.  
Each garment must be packed with  
butterfly underneath collar.