

Label: LINDBERGH	Description : LINDBERGH WHITE - SHIRT - all fit + size + belly band + storytelling	Output date: 22/06/16 Modification date: 9 March 2026 1:41 pm
	Label instruction no: LBH-W-2006	Design : JFI/AKR/JTG/TMA/MKS

Label and Belly band instruction

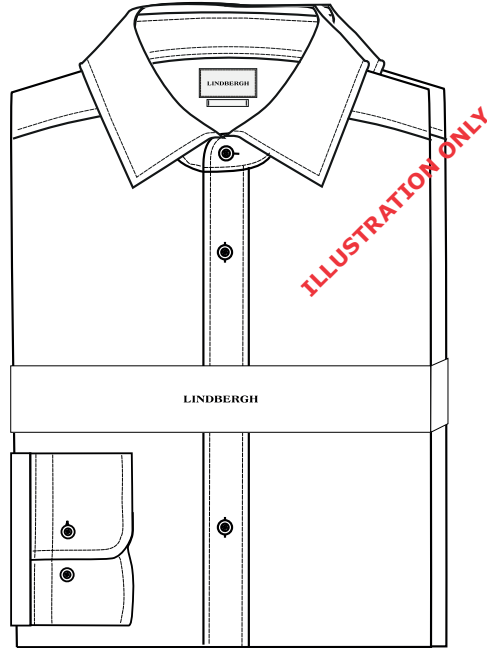

LBH-W-720A-PK

Technical sketch

FRONT



BACK

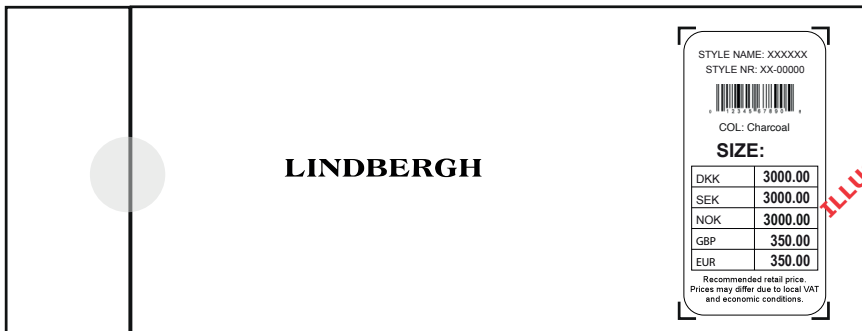

Label: LINDBERGH	Description : LINDBERGH WHITE - SHIRT - all fit + size + belly band + storytelling	Output date: 22/06/16 Modification date: 9 March 2026 1:41 pm
	Label instruction no: LBH-W-2006	Design : JFI/AKR/JTG/TMA/MKS

Label and Belly band instruction

Print instruction for Storytelling

FRONT

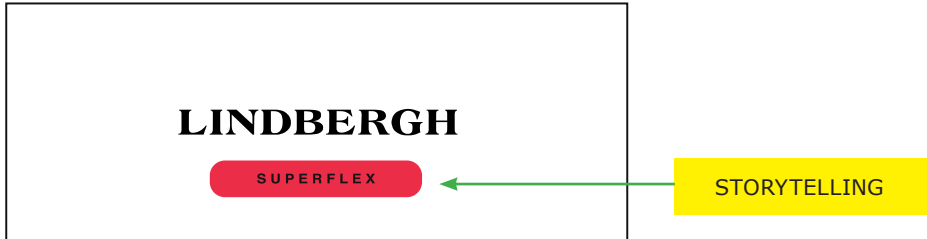

Artwork / options: Size



**PLEASE CHECK PROGRAM
FOR KIND OF STORYTELLING**

Print instruction for Sticker placement

BACK

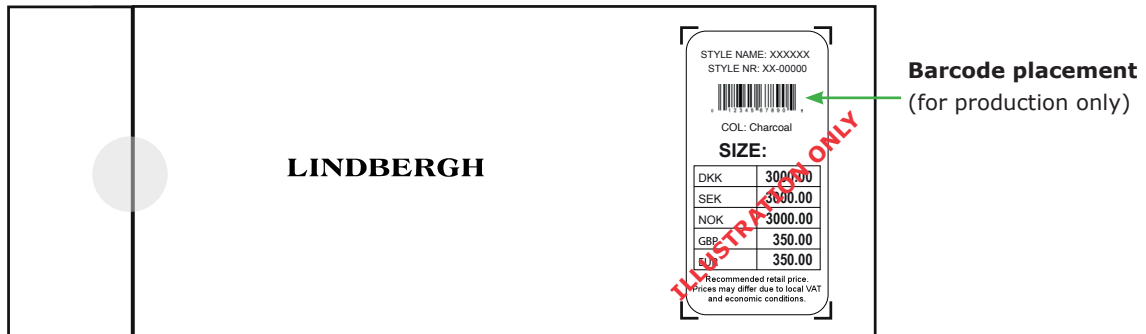

BACK

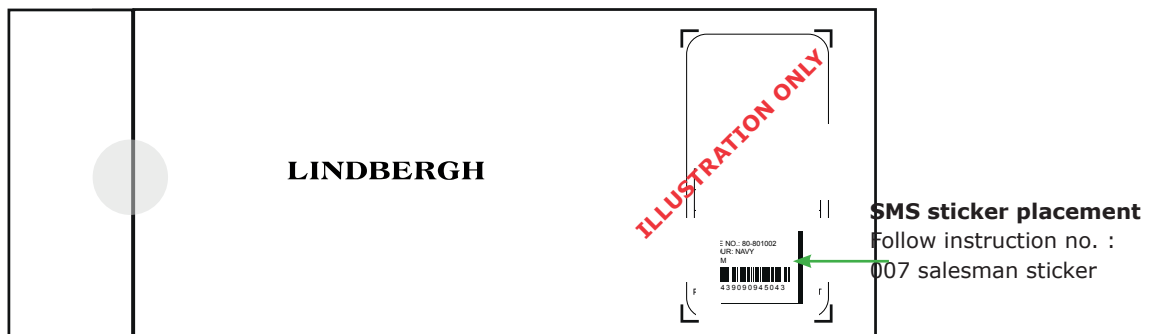

Label: LINDBERGH	Description : LINDBERGH WHITE - SHIRT - all fit + size + belly band + storytelling	Output date: 22/06/16 Modification date: 9 March 2026 1:41 pm
	Label instruction no: LBH-W-2006	Design : JFI/AKR/JTG/TMA/MKS

Label and Belly band instruction

LABEL LBH-W-838

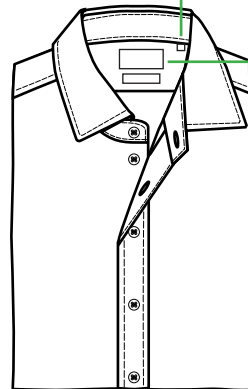

PLACEMENT:

Size label:
Please place 6 cm
from C.B at collar
stand.

Neck label must be
placed 1,5 cm below
collar stand. Stitch
only both sides (open
top/bottom)

**PLEASE CHECK MEASUREMENT CHART
FOR KIND OF FIT LABEL**

SIZE LABEL LBH-W-842

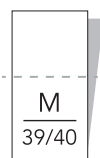

PLEASE CHECK MEASUREMENT CHART FOR KIND OF SIZE LABEL

Label: LINDBERGH	Description : LINDBERGH WHITE - SHIRT - all fit + size + belly band + storytelling	Output date: 22/06/16 Modification date: 9 March 2026 1:41 pm
	Label instruction no: LBH-W-2006	Design : JFI/AKR/JTG/TMA/MKS

Label and Belly band instruction

STORYTELLING LABEL:



See program
For label number

PLACEMENT :

Below main label
= 1 cm

Stitch both sides.
Col. match label colour

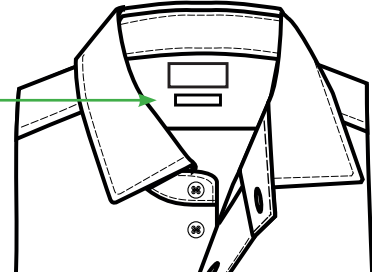

2 STORYTELLING LABELS:



See program
For label number

PLACEMENT :

Distance between
the storytelling
labels is 1 cm

Stitch both sides.
Col. match label colour

Storytelling label 1
Storytelling label 2

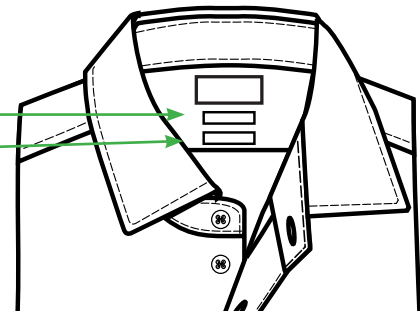

Label: LINDBERGH	Description : LINDBERGH WHITE - SHIRT - all fit + size + belly band + storytelling	Output date: 22/06/16 Modification date: 9 March 2026 1:41 pm
	Label instruction no: LBH-W-2006	Design : JFI/AKR/JTG/TMA/MKS

Label and Belly band instruction

Folding and packing instruction

Folded and packed:

Width: 21 cm

Height: 36 cm

L/S:

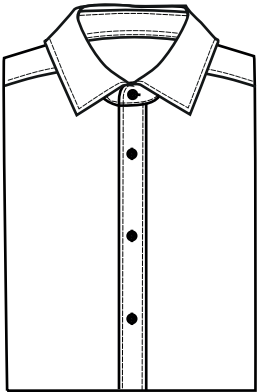

No metal needle
in the shirt

S/S:

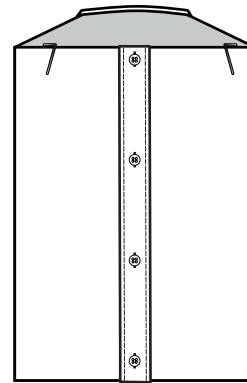
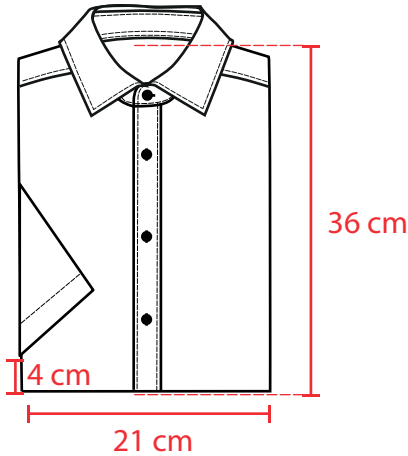

Please use plastic clips
to fix the shirt

Cardboard

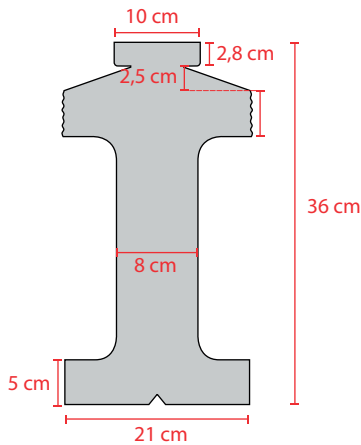
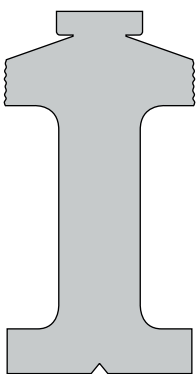

Tissue paper

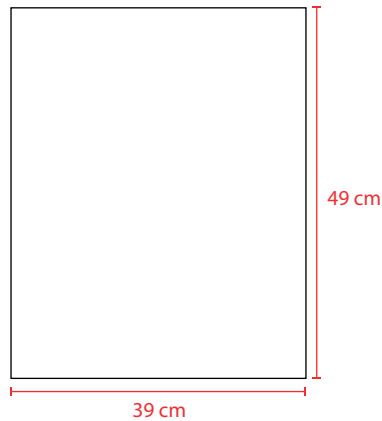

4 layers of
tissue paper

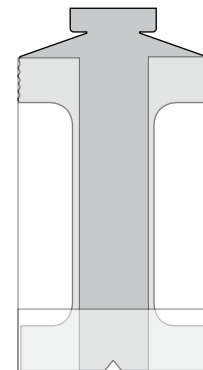

Tissue paper
placed and folded as
sketch

Plastic collar stand (inside collar)



Plastic butterfly (for shirts with fixed collar)



Single butterfly to fix collar.
Each garment must be packed with
butterfly underneath collar.