

Label: M O R G A N®	Date: 10/03-2026	Design: AKR	Style no:
Description: Shirts	Label instructions no.: MO-2015 Technical shirt		Model:

Label instruction

MO-180 neck label



Stitch all 4 sides.
Main colour of the label.



MO-260 HANGTAG + MO-255 technical hangtag

To be placed in the second buttonhole from the top.



Please place in front of main hangtag

MO-175 Storytelling label



To be placed 0,2 cm below neck label. Stitch all 4 sides.
Main colour of the label.

MO-251 shirt tag

To be folded around the collar, center back.



MO-601A Size label

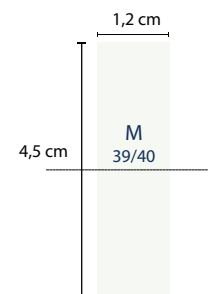

Placement:
Please place 6 cm from C.B at collar stand.

10 mm visible

S 37/38	M 39/40	L 41/42
XL 43/44	2XL 45/46	3XL 47/48



CARE LABEL

It is to be made by The supplier. Pls. Send Sample for approval before production

Label: M O R G A N®	Date: 10/03-2026	Design: AKR	Style no:
Description: Shirts	Label instructions no.: MO-2015 Technical shirt		Model:

BAR CODE: Backside at the second hangtag

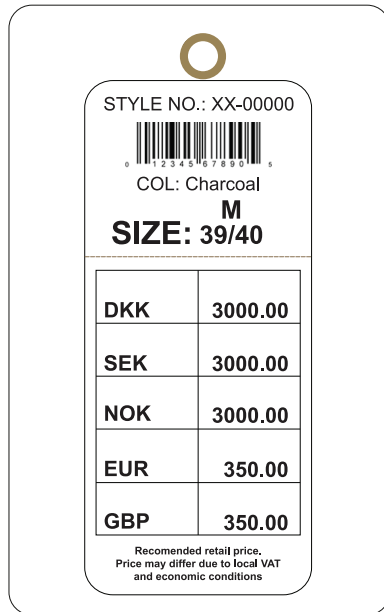

Stick barcode on the back of the hangtag-center placed

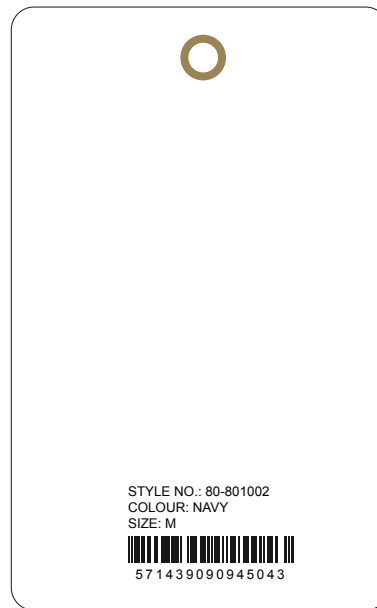





Follow instruction no. : 007 salesman sticker

Label: M O R G A N®	Date: 10/03-2026	Design: AKR	Style no:
Description: Shirts	Label instructions no.: MO-2015 Technical shirt		Model:

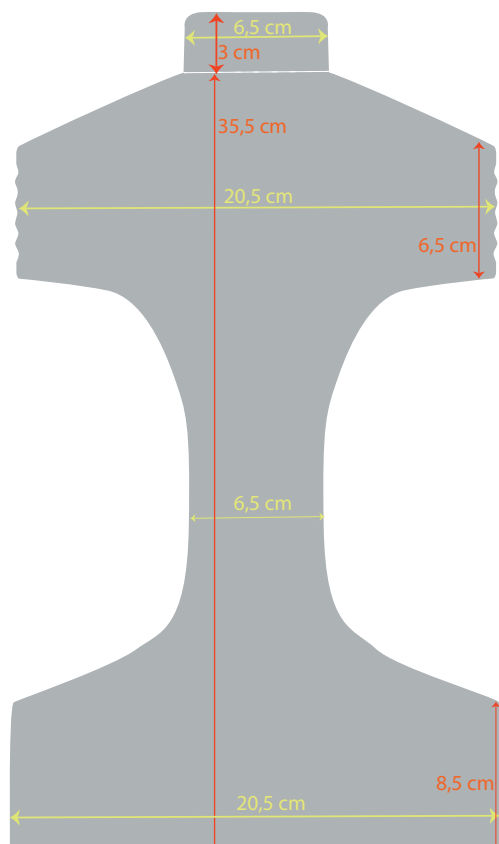
MO-402 Cardboard:

Please make the cardboard after the instructions below.



Golden line Colours	
Tofu 11-4801 TCX	
Estate blue 19-4027 TCX	
White	

Cardboard:	Quality/colour as sample
"M"	Embossed own W: 5,9 H: 5,3 cm
"Morgan" "Shirtmaker since 1985"	Font : Bickham script Pro_ But changed as Sketch Font: Courier New_ with more space between letters as sketch

Label: M O R G A N®	Date: 10/03-2026	Design: AKR	Style no:
Description: Shirts	Label instructions no.: MO-2015 Technical shirt		Model:

Tissue paper: MO-401

*Crafted from premium
two-ply long-staple cotton
with a refined wrinkle-free finish.*

*Designed for lasting comfort,
durability, and a crisp look
that stays fresh
and elegant all day.*

Morgan
Shirtmaker since 1985

Golden line Colours	
Fennel seed 17-0929 TCX	

Label: M O R G A N®	Date: 10/03-2026	Design: AKR	Style no:
Description: Shirts	Label instructions no.: MO-2015 Technical shirt		Model:

Folding & packing instruction :

SHORT SLEEVE

LONG SLEEVE

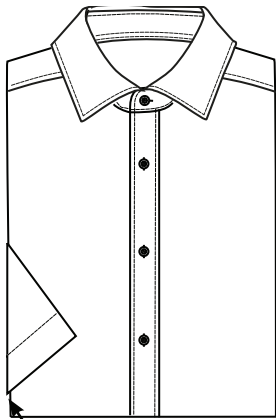

4 CM FROM BOTTOM

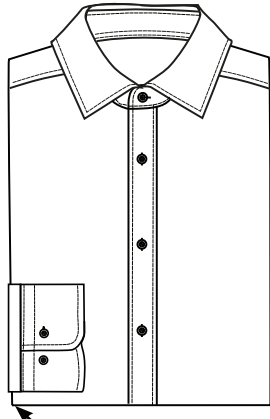

1 CM FROM BOTTOM

FOLDED & PACKED
21 CM WIDE /
36 CM HIGH. EACH
GARMENT PACKED IN
POLYBAG WITH SIZE &
STICKER.

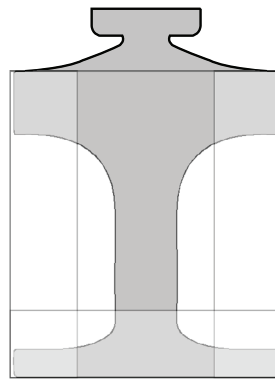

8 LAYERS OF TISSUE.
35X45 CM.
UPPER TISSUE
IS WITH LOGO PRINT

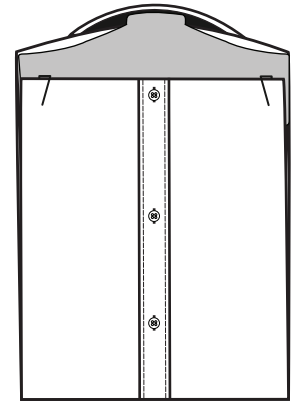

PLEASE USE CLIPS TO
FIX THE SHIRT

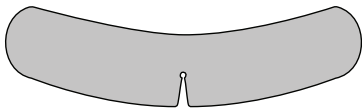

SINGLE BUTTERFLY TO
FIX COLLAR.
EACH GARMENT
PACKED W/ BUTTERFLY
UNDERNEATH COLLAR

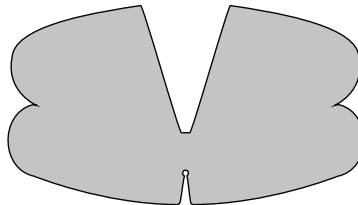

DOUBLE BUTTERFLY
TO FIX BUTTENDOWN
COLLAR. EACH
GARMENT PACKED
W/BUTTERFLY
UNDERNEATH COLLAR



PLASTIC
COLLAR STAND

Label: M O R G A N®	Date: 10/03-2026	Design: AKR	Style no:
Description: Shirts	Label instructions no.: MO-2015 Technical shirt		Model:

Attachment:

Tape to be stitched
Together with matching
Thread & attached to
Shirt with needle.

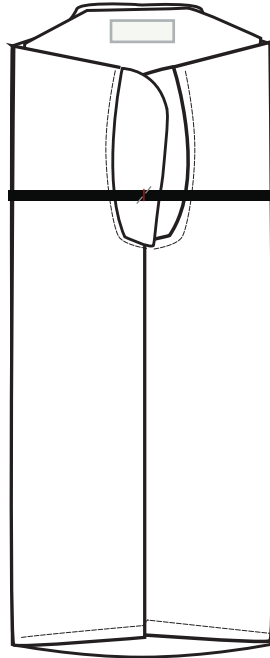
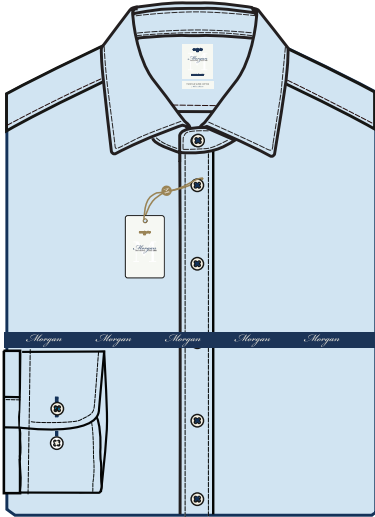

MO-161A Bellytape as MO-161 in new colour

W: 1,1 cm

main col:



Estate blue 19-4027 TCX

logo colour



Tofu 11-4801 TCX

Morgan

Fond: Bickham script Pro
(BUT Changed as sketch)



CENTER FRONT

Label: M O R G A N®	Date: 10/03-2026	Design: AKR	Style no:
Description: Shirts	Label instructions no.: MO-2015 Technical shirt		Model:

CHECK MEASUREMENT CHART FOR CORRECT SIZE CHART

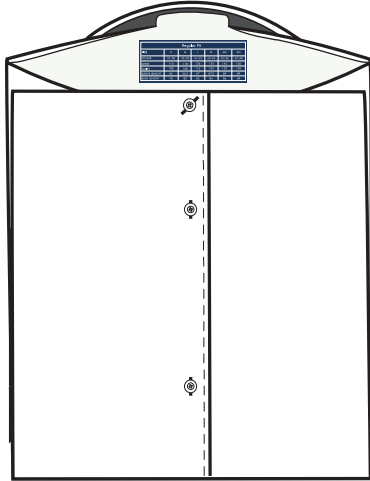



Regular Fit L/S						
SIZE	S	M	L	XL	2XL	3XL
COLLAR	37/38	39/40	41/42	43/44	45/46	47/48
CHEST	108	116	124	132	140	148
WAIST	100	108	116	124	134	146
SLEEVE LENGHT	66	66,5	67	67,5	68	68,5
BACK LENGHT	78	80	82	84	86	89

Regular Fit S/S						
SIZE	S	M	L	XL	2XL	3XL
COLLAR	37/38	39/40	41/42	43/44	45/46	47/48
CHEST	108	116	124	132	140	148
WAIST	100	108	116	124	134	146
SLEEVE LENGHT	24	25	26	26,5	27	28
BACK LENGHT	78	80	82	84	86	89

Comfort Fit L/S						
SIZE	S	M	L	XL	2XL	3XL
COLLAR	37/38	39/40	41/42	43/44	45/46	47/48
CHEST	110	118	126	134	142	150
WAIST	104	112	120	130	142	152
SLEEVE LENGHT	65	65,5	66	66,5	67	67,5
BACK LENGHT	78	80	82	84	86	89

Comfort Fit S/S						
SIZE	S	M	L	XL	2XL	3XL
COLLAR	37/38	39/40	41/42	43/44	45/46	47/48
CHEST	110	118	126	134	142	150
WAIST	104	112	120	130	142	152
SLEEVE LENGHT	24	25	26	26,5	27	27,5
BACK LENGHT	78	80	82	84	86	89

Golden line Colours	
white	
Estate blue 19-4027 TCX	

Size info sticker:	
Sticker	W: 7,5 H: 3 cm
Font:	Tw Cen MT
Placement:	1,5 cm below foldingline