

Label: SHINE ORIGINAL	Description : LINDBERGH WHITE - SHIRTS - all fit + sizes	Date: 04/08/20 Modification date: 15 January 2026 10:03 am
	Label instruction no: SHO-2002	Design : MKS

Tag placement

Hangtag must be fixed with knot at 2nd button hole. See sketch below

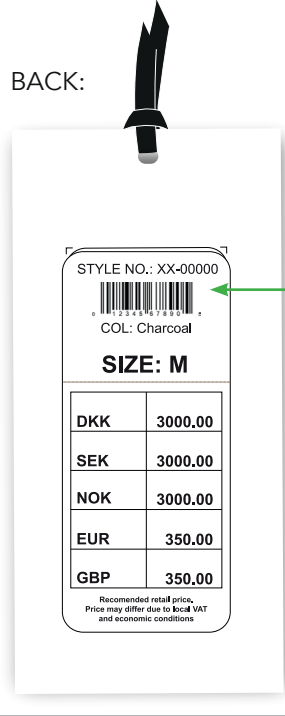

Barcode placement (for production only) inside hangtag.
Place price sticker at fixing points.

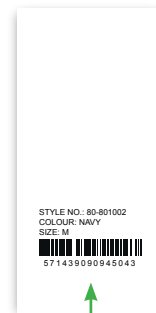
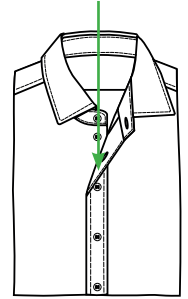

Follow instruction no. :
007 salesman sticker

Label: SHINE ORIGINAL	Description : LINDBERGH WHITE - SHIRTS - all fit + sizes	Date: 04/08/20 Modification date: 15 January 2026 10:03 am
	Label instrution no: SHO-2002	Design : MKS

MAIN LABEL SIDE FOLDED

PLEASE CHECK MEASUREMENT CHART FOR KIND OF FIT LABEL

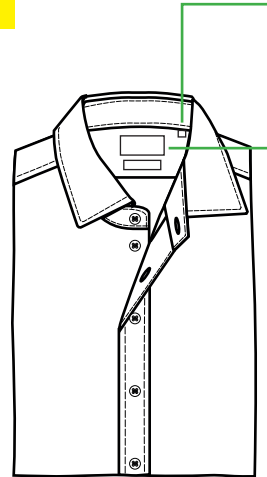

PLACEMENT:

Size label:
Please place 6 cm from C.B at collar stand.

Neck label must be placed 1,5 cm below collar stand. Stitch only both sides (open top/bottom)

PLEASE CHECK MEASUREMENT CHART FOR KIND OF SIZE LABEL

SIZE LABEL:

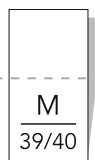
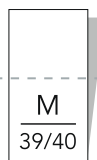

Label: SHINE ORIGINAL	Description : LINDBERGH WHITE - SHIRTS - all fit + sizes	Date: 04/08/20 Modification date: 15 January 2026 10:03 am
	Label instruction no: SHO-2002	Design : MKS

STORYTELLING LABEL:



See program
For label number

PLACEMENT :

Below main label
= 1 cm
Stitch both sides.
Col. match label colour

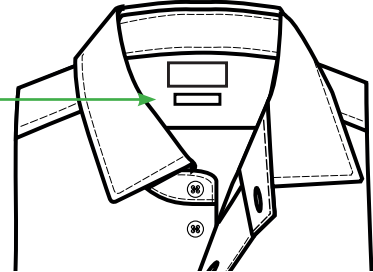

2 STORYTELLING LABELS:



See program
For label number

PLACEMENT :

Distance between
the storytelling
labels is 1 cm
Stitch both sides.
Col. match label colour

Storytelling label 1
Storytelling label 2

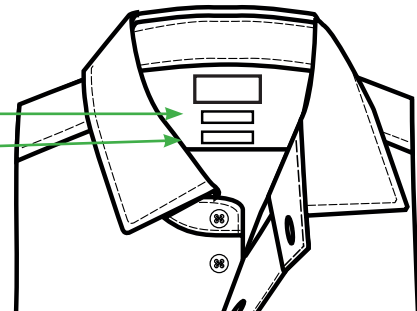

Label: SHINE ORIGINAL	Description : LINDBERGH WHITE - SHIRTS - all fit + sizes	Date: 04/08/20 Modification date: 15 January 2026 10:03 am
	Label instruction no: SHO-2002	Design : MKS

Folding and packing instruction

Folded and packed:
Width: 21 cm
Height: 36 cm

L/S:

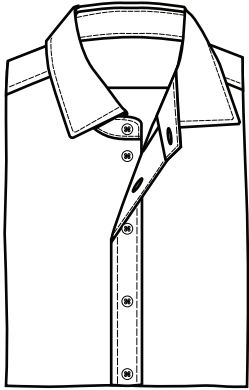

S/S:

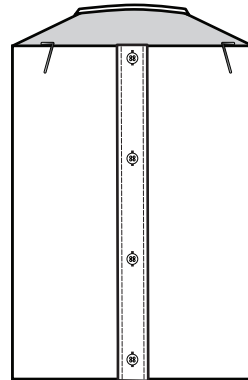
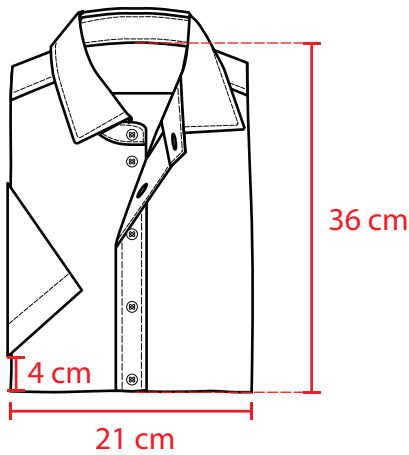

Please use metal clips
to fix the shirt

Cardboard

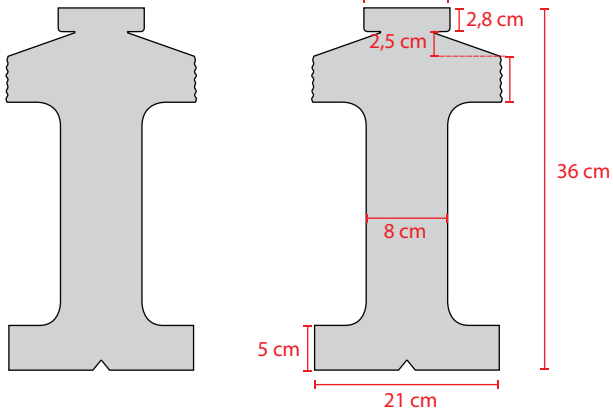

Tissue paper

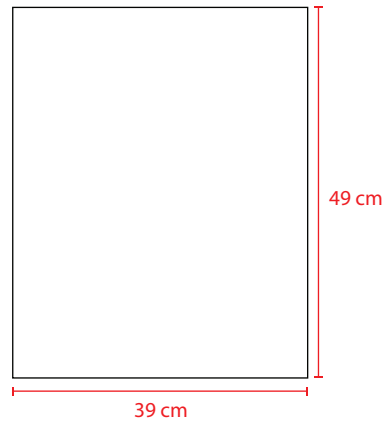

4 layers of
tissue paper

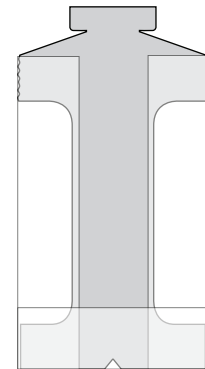

Tissue paper
placed and folded as
sketch

Plastic collar stand
(inside collar)



Plastic butterfly
(for shirts with fixed collar)

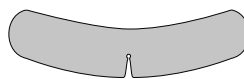

Single butterfly to fix collar.
Each garment must be packed with
butterfly underneath collar.