

<b>Label:</b>  <b>SHINE ORIGINAL</b>	<b>Description :</b> SHINE - SUITS both size 50 and M + ALL FIT	<b>Date: 07/07/21</b> <b>Modification date:</b> <b>16 June 2025 1:18 pm</b>
	<b>Label instruction no:</b> SHO-6000	<b>Design :</b> MKS

# BLAZER

## HANGTAG:

FRONT:

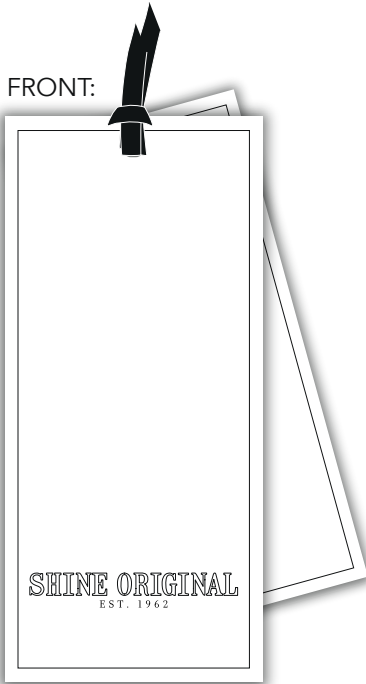

BACK:

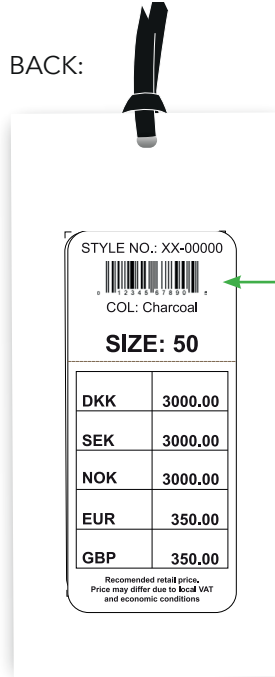

Barcode placement (for production only) inside hangtag.  
Place price sticker at fixing points.

Hangtag fixed behind lapel with black metal safty pin

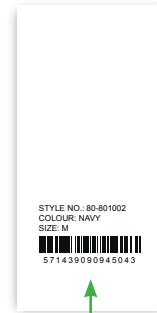
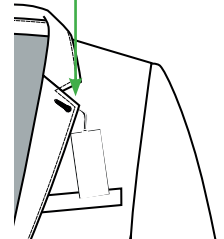

Follow instruction no. :  
007 salesman sticker

<b>Label:</b>  <b>SHINE ORIGINAL</b>	<b>Description :</b> SHINE - SUITS both size 50 and M + ALL FIT	<b>Date: 07/07/21</b> <b>Modification date:</b> 16 June 2025 1:18 pm
	<b>Label instruction no:</b> SHO-6000	<b>Design :</b> MKS

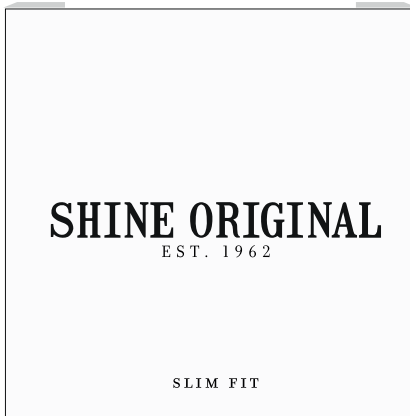

**PLACEMENT:**  
3,5 cm from inner pocket  
-right side

Stitch all 4 sides.  
Col. match label colour

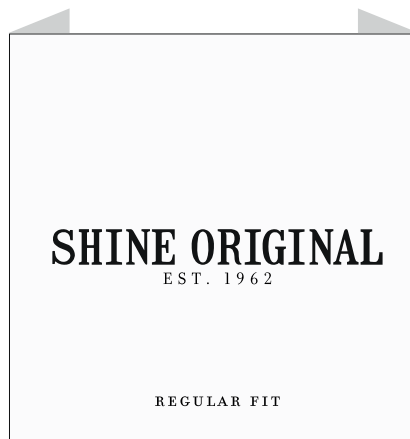
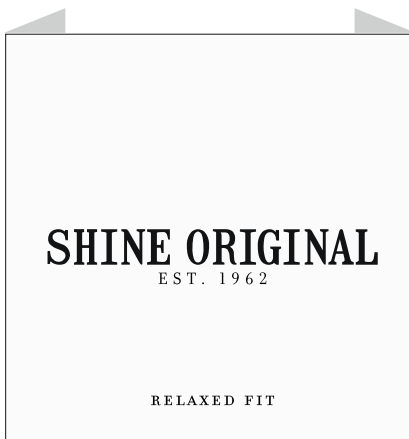
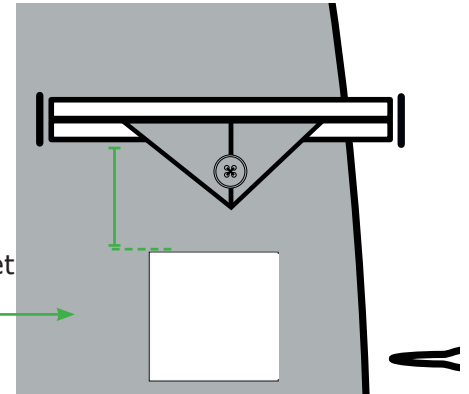

**PLEASE CHECK MEASUREMENT CHART FOR KIND OF FIT LABEL**

<b>Label:</b>  <b>SHINE ORIGINAL</b>	<b>Description :</b> SHINE - SUITS both size 50 and M + ALL FIT	<b>Date: 07/07/21</b> <b>Modification date:</b> <b>16 June 2025 1:18 pm</b>
	<b>Label instruction no:</b> SHO-6000	<b>Design :</b> MKS

**PLEASE CHECK MEASUREMENT CHART FOR KIND OF SIZE LABEL**

Please place the label  
inside left inner pocket  
-right side

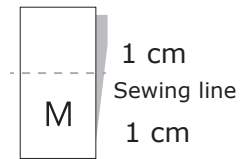
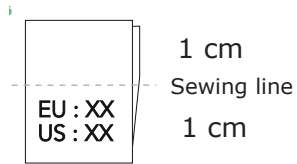

Always place carelabel  
In left inner pocket  
-left side

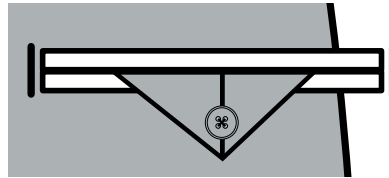

<b>Label:</b>  <b>SHINE ORIGINAL</b>	<b>Description :</b> SHINE - SUITS both size 50 and M + ALL FIT	<b>Date: 07/07/21</b> <b>Modification date:</b> 16 June 2025 1:18 pm
	<b>Label instruction no:</b> SHO-6000	<b>Design :</b> MKS

**STORYTELLING LABEL:**



See program  
For label number

**PLACEMENT :**

Below main label  
= 1 cm

Stitch both sides.  
Col. match label colour

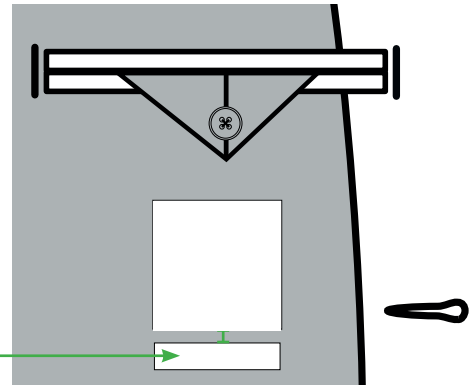

**2 STORYTELLING LABELS:**



See program  
For label number

**PLACEMENT :**

Distance between  
the storytelling  
labels is 1 cm

Stitch both sides.  
Col. match label colour

Storytelling label 1

Storytelling label 2

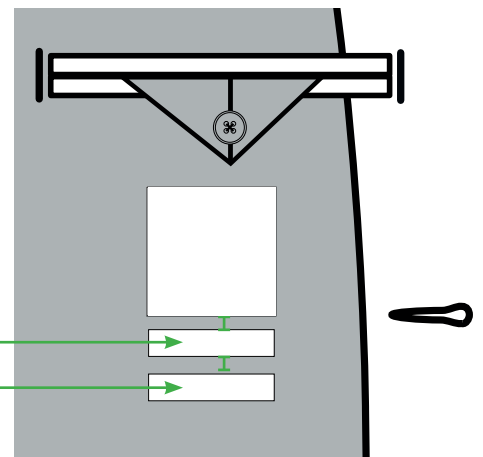

<b>Label:</b>  <b>SHINE ORIGINAL</b>	<b>Description :</b> SHINE - SUITS both size 50 and M + ALL FIT	<b>Date: 07/07/21</b> <b>Modification date:</b> <b>16 June 2025 1:18 pm</b>
	<b>Label instruction no:</b> SHO-6000	<b>Design :</b> MKS

## PANTS

### PLACEMENT:

Hangtag must be fixed with knot at beltloop. See sketch below

FRONT:

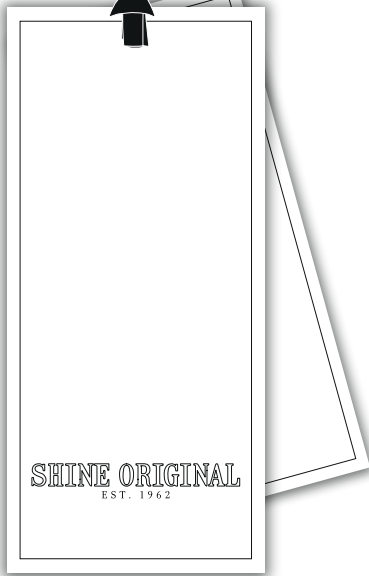

BACK:

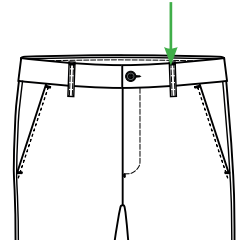
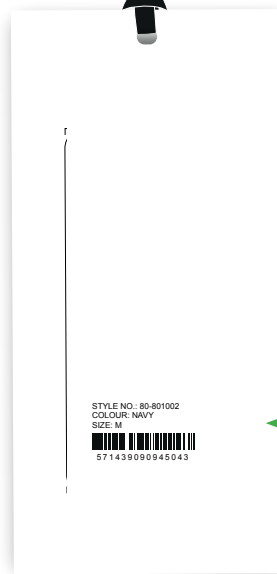

Inside hangtag.  
Place price sticker at fixing points.

Follow instruction no. :  
007 salesman sticker.  
For both salemans  
sample + production

<b>Label:</b>  <b>SHINE ORIGINAL</b>	<b>Description :</b> SHINE - SUITS both size 50 and M + ALL FIT	<b>Date: 07/07/21</b> <b>Modification date:</b> 16 June 2025 1:18 pm
	<b>Label instruction no:</b> SHO-6000	<b>Design :</b> MKS

## PANTS



### PLACEMENT - INSIDE:

Place main label 8 cm from CF- right hand side and centered with the waistband

Stitch both sides.  
Col. match label colour

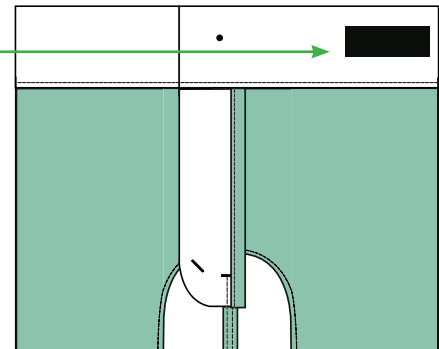

**PLEASE CHECK MEASUREMENT CHART FOR KIND OF FIT LABEL**

### SIZE LABEL:

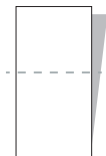

**SAME AS BLAZER**

### PLACEMENT - INSIDE:

Place size label 8 cm from CF - left hand side.

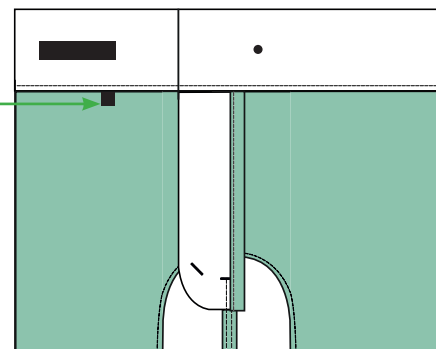

<b>Label:</b>  <b>SHINE ORIGINAL</b>	<b>Description :</b> SHINE - SUITS both size 50 and M + ALL FIT	<b>Date: 07/07/21</b> <b>Modification date:</b> 16 June 2025 1:18 pm
	<b>Label instruction no:</b> SHO-6000	<b>Design :</b> MKS

**STORYTELLING LABEL:**



See program  
For label reference

Place storytelling label  
8 cm from CF- left  
hand and centered  
with the waistband

Stitch both sides.  
Col. match label colour

**PLACEMENT - INSIDE:**

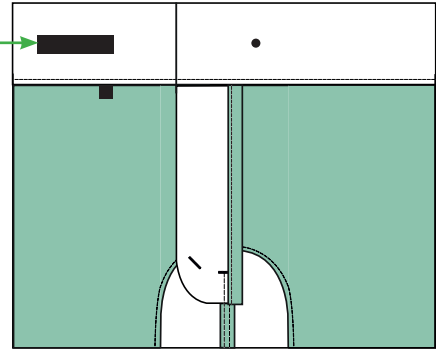

**2 STORYTELLING LABELS:**

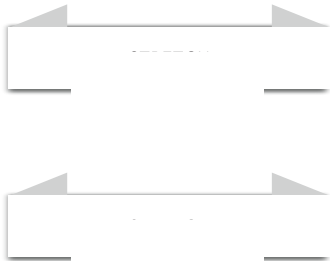

See program  
For label reference

Place storytelling label  
8 cm from CF- left  
hand and centered  
with the waistband.  
Distance in between  
the 2 labels is 0,5 cm.

Stitch both sides.  
Col. match label colour

**PLACEMENT - INSIDE:**

