

TMI & CONSTRUCTION

- VERSION 9

TECHNICAL MEASURING INSTRUCTION



TMI & CONSTRUCTION

1. ACROSS SHOULDER

The width across the top back, from shoulder seam to seam.

2. CHEST

Measure around area right under the arms.

3. WAIST

Measure around waist

4A. SLEEVE

Measure from shoulder seam to sleeve end

4B. SLEEVE

Measure from center back to middle of sleeve end

5. BACK LENGTH CB

Measure center back from collar seam to bottom

6. BOTTOM SLEEVE

Measure around sleeve opening

7. THIGH

Measure around thigh right below crotch

8. KNEE

Measure around knee 35 cm below crotch

9. ARMHOLE

Measure around armhole curve

10. BOTTOM LEG

Measure around leg opening

11. INSEAM

Measure between top inside crotch to bottom leg

12. OUTSEAM LENGTH

Measure top waist to bottom leg

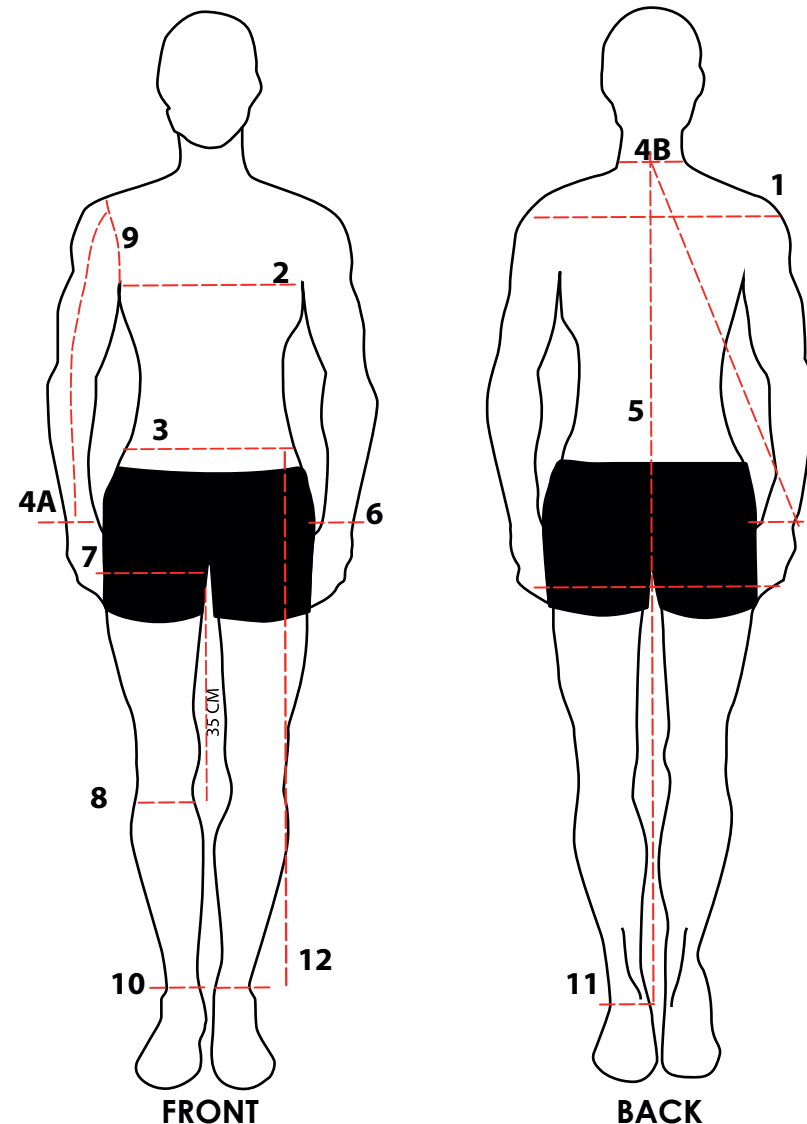

TMI & CONSTRUCTION

FIG.1

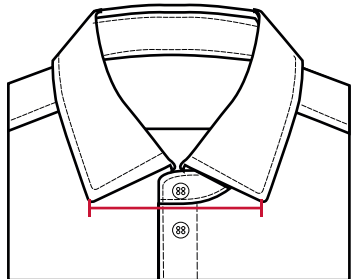

Collar spread

FIG.2

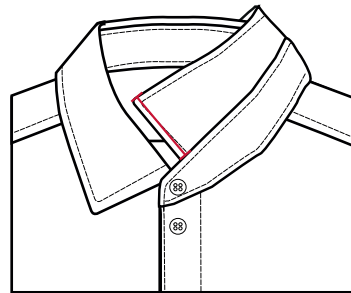

Collar point

FIG.3

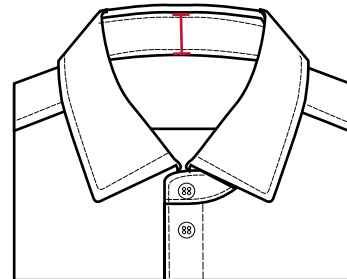

Collar band height CB

FIG.4

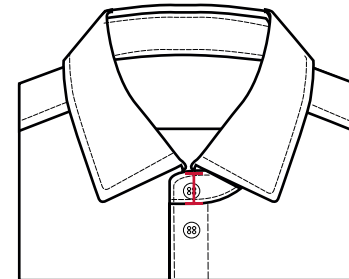

Collar band height CF

FIG.5

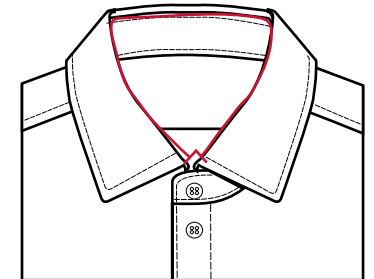

Collar opening inside

FIG.6

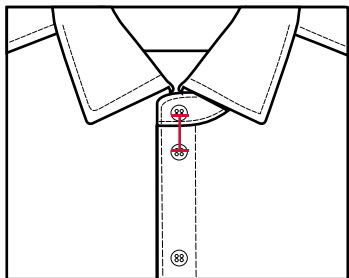

Distance between 1st. and 2nd.button

FIG.7

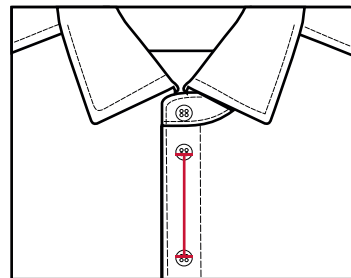

Distance between other buttons

FIG.8

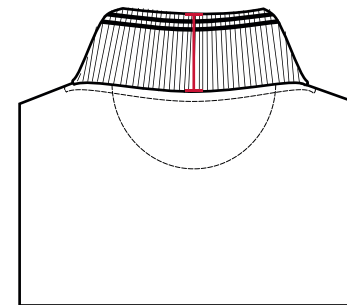

Collar height CB

FIG.9

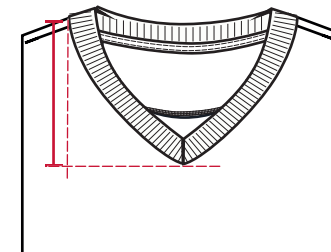

Neck drop front v-neck

FIG.10

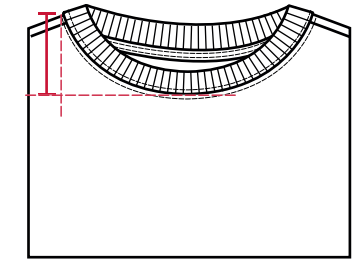

Neck drop front

FIG.11

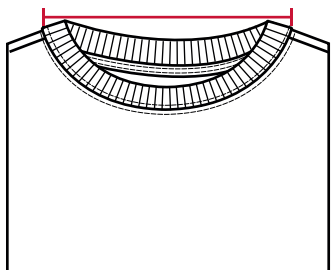

Neck width at shoulder

FIG.12

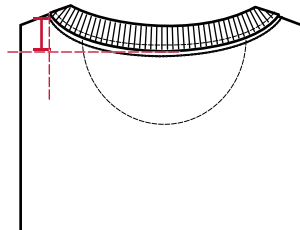

Neck drop back

FIG.13

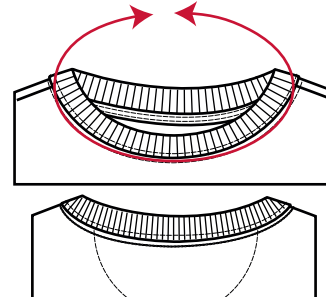

Neck opening

FIG.14

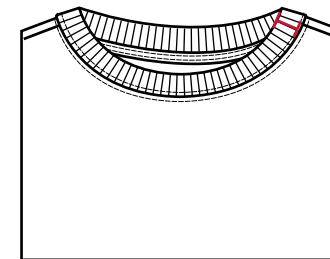

Neck rib height

FIG.15

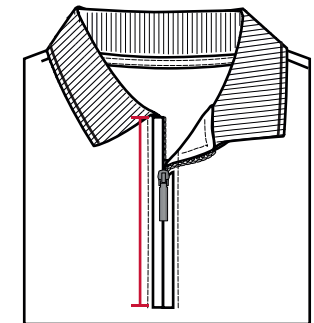

Zipper length

TMI & CONSTRUCTION

FIG.16

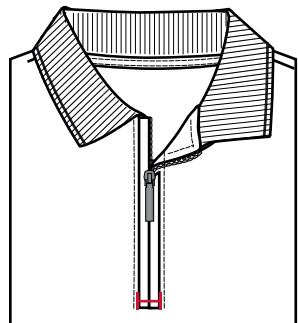

Zipper lips width total

FIG.17

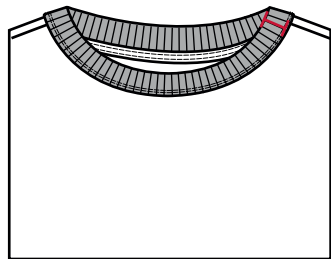

Neck edging

FIG.18

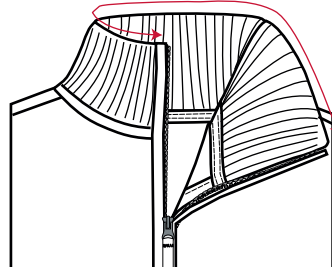

Neck opening at collar top

FIG.19

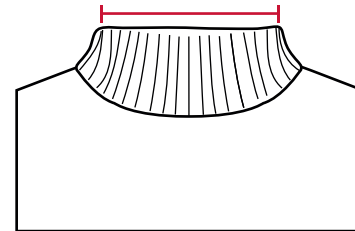

Neck width at collar top x 2

FIG.20

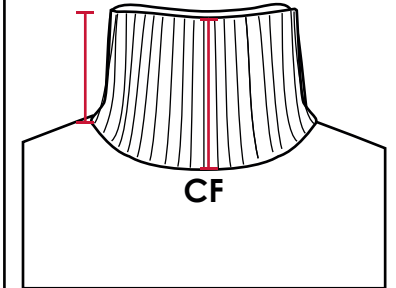

Roll neck height (Full length)

FIG.21

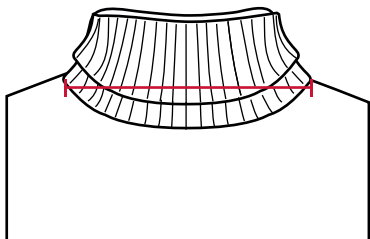

Neck width at top shoulder

FIG.22

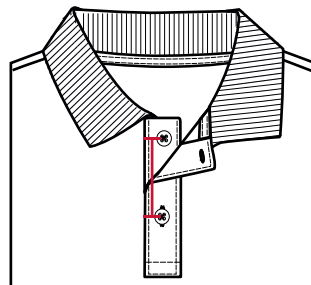

Button distance

FIG.23

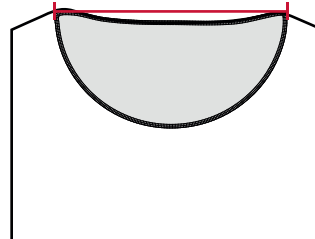

Neck mirror width

FIG.24

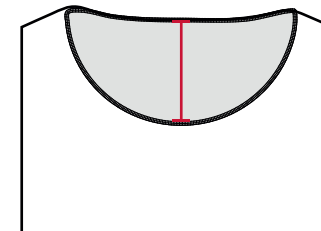

Neck mirror height at center CB

FIG.25

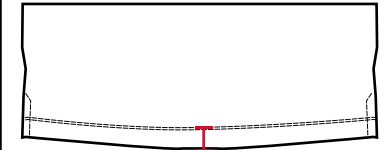

Bottom hem

FIG.26

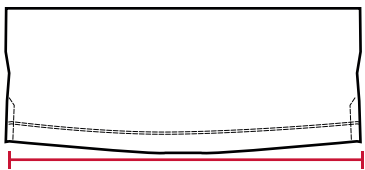

Bottom width x 2

FIG.27

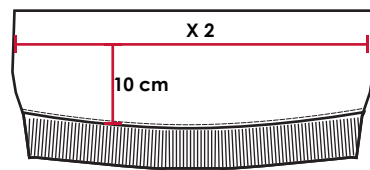

Bottom width 10 cm above rib

FIG.28

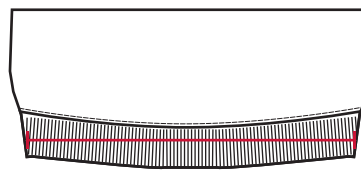

Bottom width with rib x 2

FIG.29

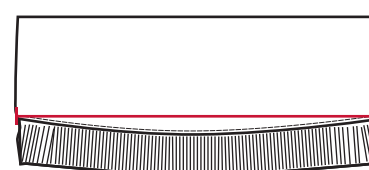

Bottom stretched x 2

FIG.30

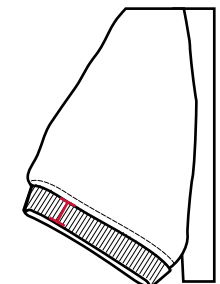

Sleeve rib width

TMI & CONSTRUCTION

FIG.31

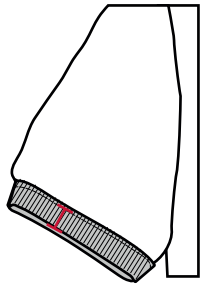

Sleeve edging

FIG.32

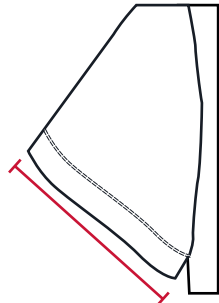

Sleeve opening x 2

FIG.33

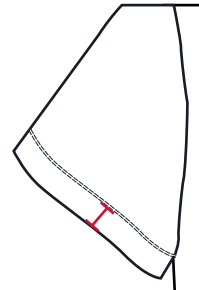

Sleeve hem

FIG.34

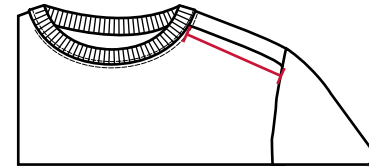

Half shoulder
at shoulder seam

FIG.35

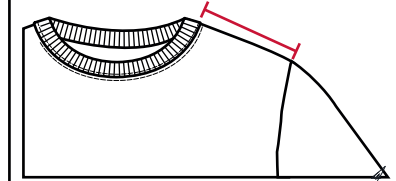

Half shoulder
at top/center
sleeve head

FIG.36 A

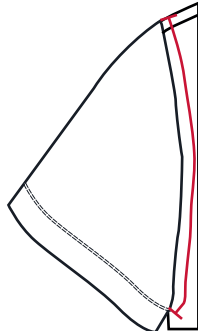

Armhole curved x 2

FIG.37

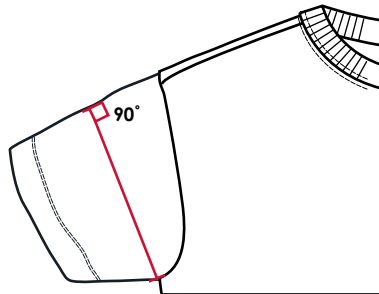

Upper arm x 2

FIG.38

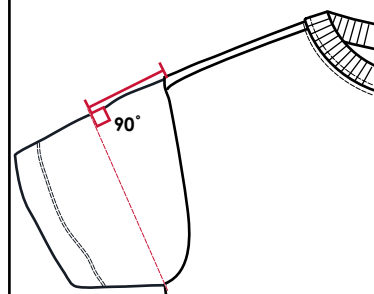

Sleeve head height

FIG.39

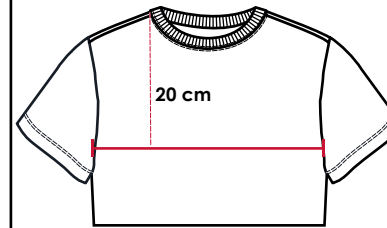

Front width 20 cm
from shoulder point

FIG.40

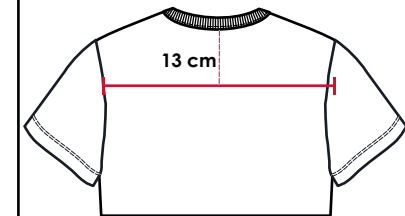

Back width 13 cm
from neck seam CB

FIG.41

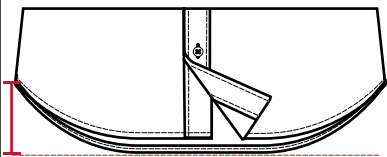

Distance between
side seam and bottom

FIG.42

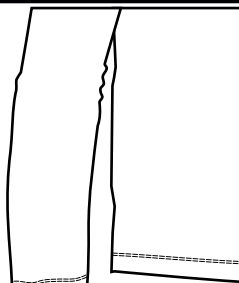

Sleeve bottom width
x 2

FIG.43

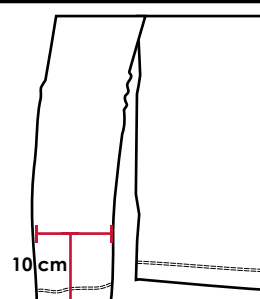

Sleeve width 10 cm
before bottom x 2

FIG.44

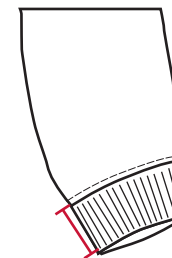

Cuff height

FIG.45

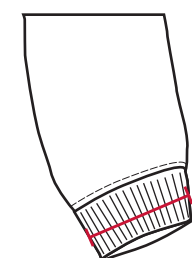

Sleeve bottom width
with rib x 2

TMI & CONSTRUCTION

FIG.46

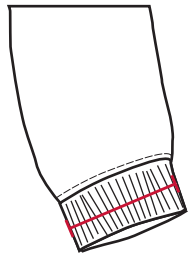

**Cuff stretched
x 2**

FIG.47

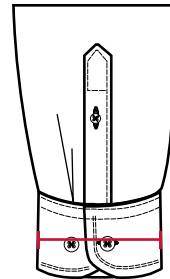

**Cuff buttoned
1st.button**

FIG.48

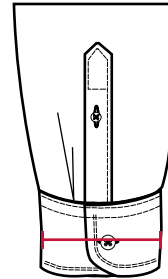

**Cuff buttoned
2nd.button**

FIG.49

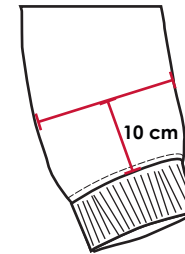

**Sleeve width 10 cm
before cuff x 2**

FIG.50

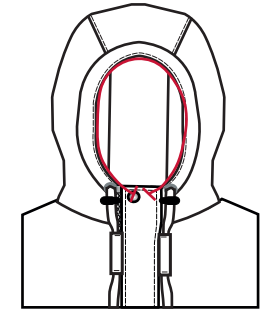

Hood opening

FIG.51

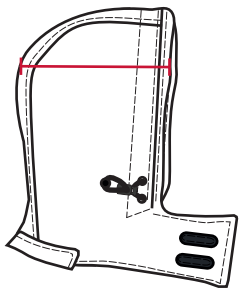

Hood depth

FIG.52

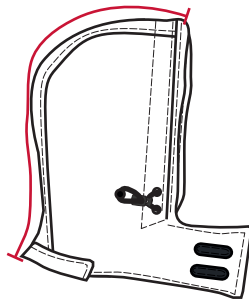

Hood length

FIG.53

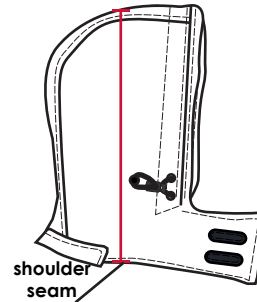

**Hood height at
shoulder**

FIG.54

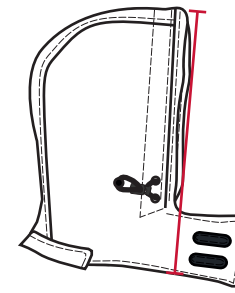

Hood height front

FIG.55

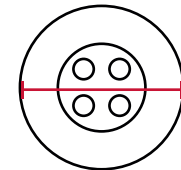

**Button size
size:mm/lignes**

FIG.56

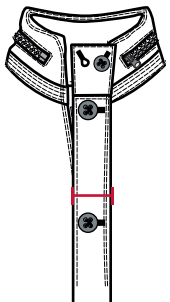

Placket width

FIG.57

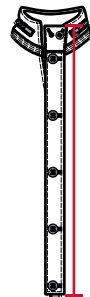

Placket length

FIG.58

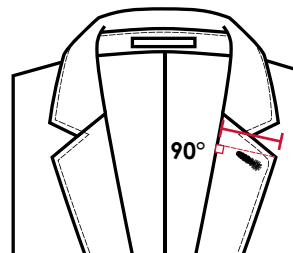

Lapel width

FIG.59

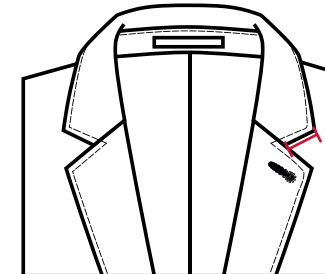

Collar point

FIG.60



Sleeve slit length

TMI & CONSTRUCTION

FIG.61

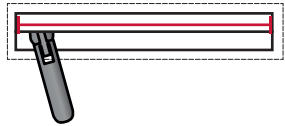

Pocket opening

FIG.62

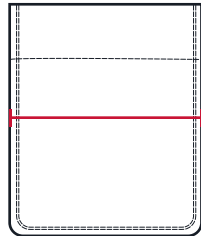

Pocket width

FIG.63

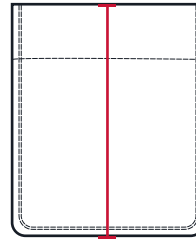

Pocket height

FIG.64

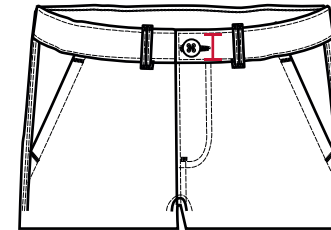

Waistband height

FIG.65

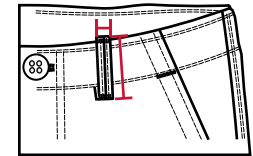

Belt loop width & height

FIG.66

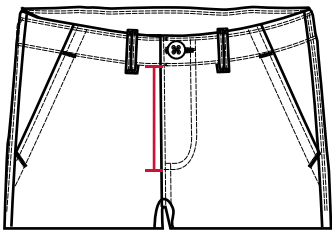

Front fly length

FIG.67

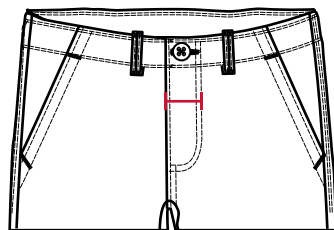

Front fly width

FIG.68

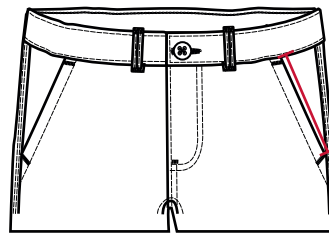

Front pocket opening

FIG.69

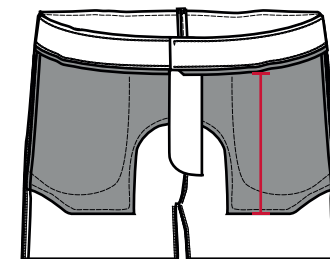

Front pocket bag depth

FIG.70

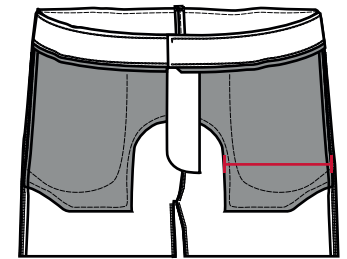

Front pocket bag width

FIG.71

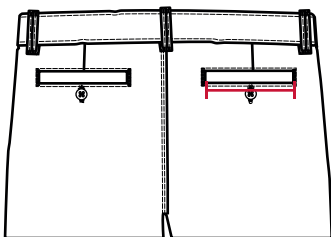

Back pocket opening

FIG.72

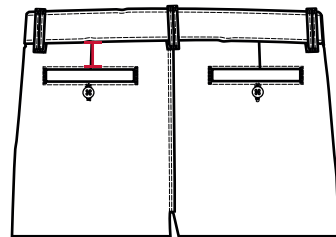

Distance waistband center back pocket

FIG.73

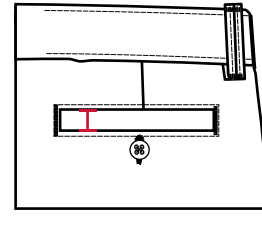

Back pocket lip width

FIG.74

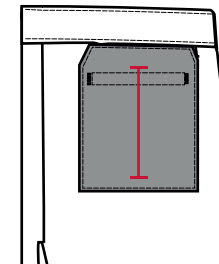

Back pocket depth

FIG.75

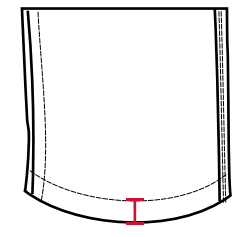

Bottom hem

TMI & CONSTRUCTION

FIG.76

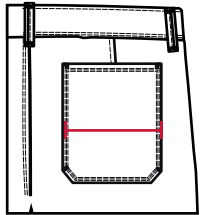

Back pocket width

FIG.77

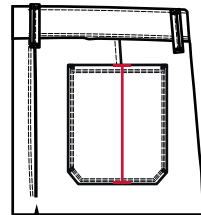

Back pocket height

FIG.78

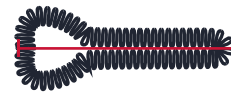

Button hole stitch length

FIG.79

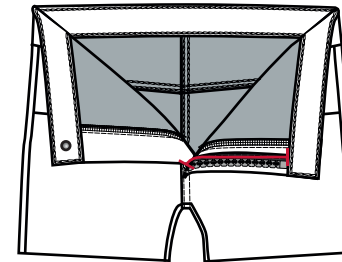

Zipper length

FIG.80

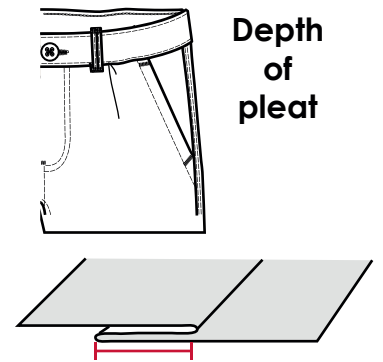

Depth of pleat

FIG.81

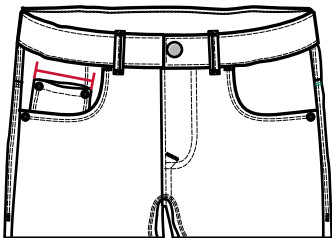

Coin pocket width

FIG.82

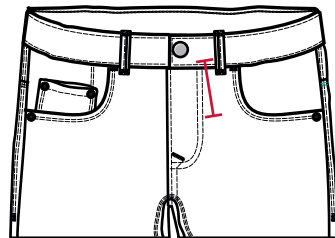

Front pocket height

FIG.83

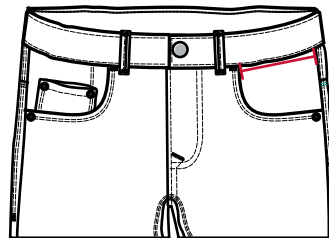

Front pocket width

FIG.84

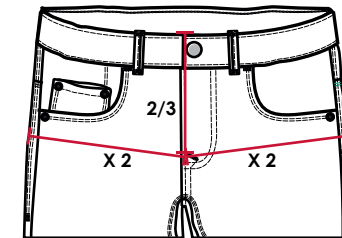

**Seat width
2/3 down front rise**

FIG.85

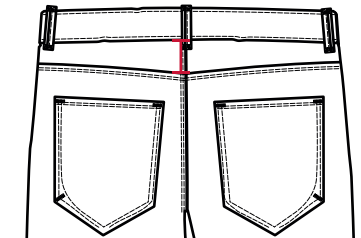

Yoke height at center back CB

FIG.86

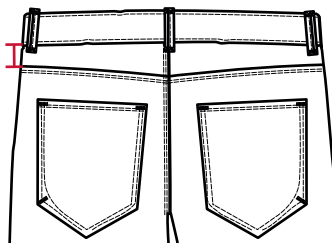

Yoke height at side seam

FIG.87

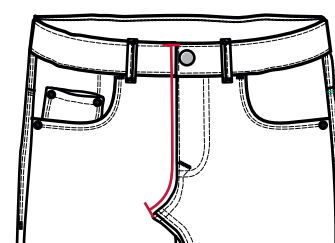

Front rise

FIG.88

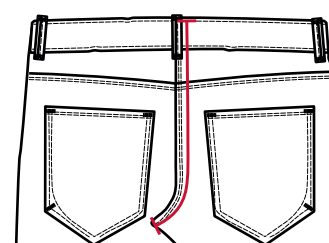

Back rise

FIG.89

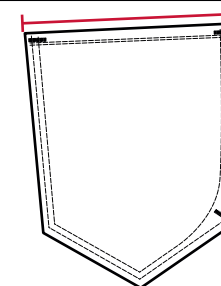

Back pocket width - top

FIG.90

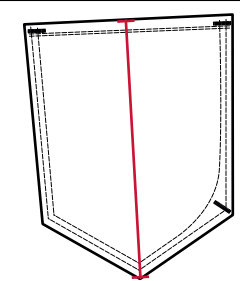

Back pocket height - center

TMI & CONSTRUCTION

FIG.91

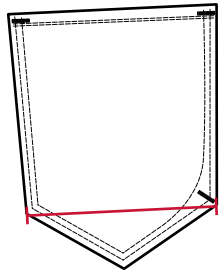

Back pocket width - bottom

FIG.92

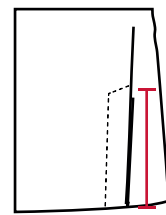

Slit length

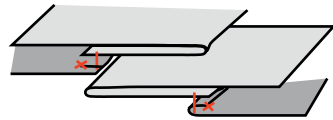
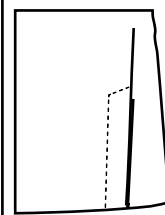

FIG.93



Slit width

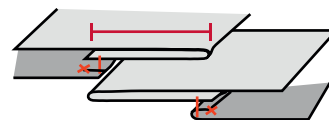
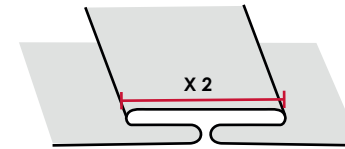
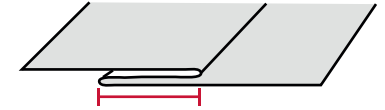

FIG.94



Box pleat width

FIG.95



Depth of pleats

FIG.96

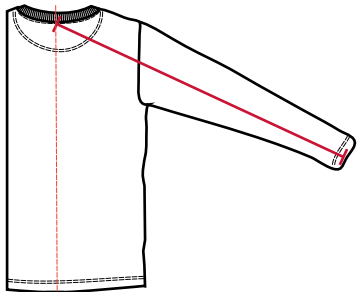

Sleeve length

Measure from center back to sleeve end at middle

FIG.97

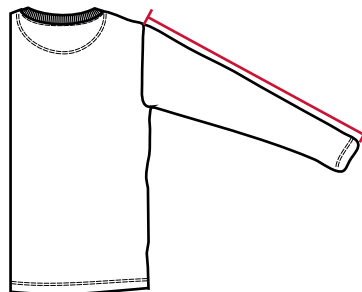

Sleeve length

Measure from shoulder seam to sleeve end

FIG.98

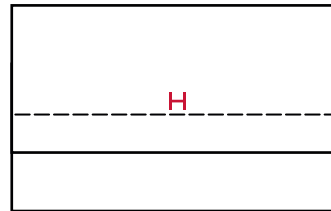

Stitch length

FIG.99

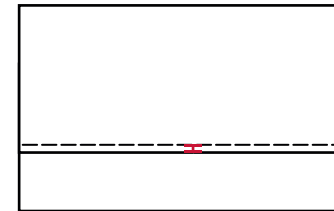

1 mm single edge stitching

FIG.100

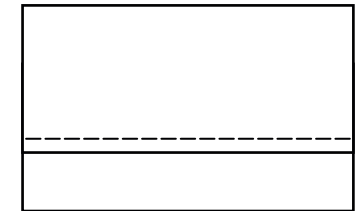

2 mm single edge stitching

FIG.101

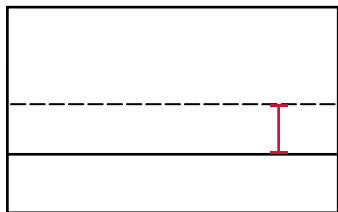

6 mm single edge stitching

FIG.102

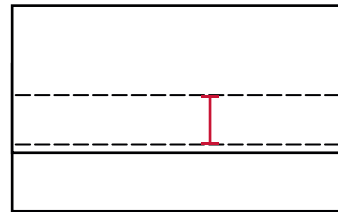

6 mm double stitching

FIG.103

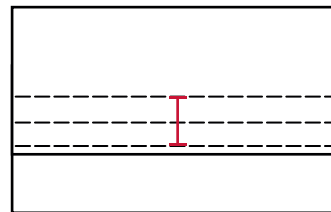

6 mm triple stitching

FIG.104

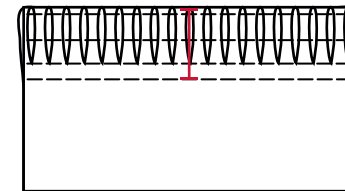

Seam allowance all over 1,5 cm with overlock seam

FIG.105

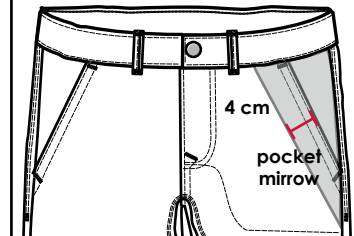

Pocket mirror with 4 cm overlap

TMI & CONSTRUCTION

FIG.106

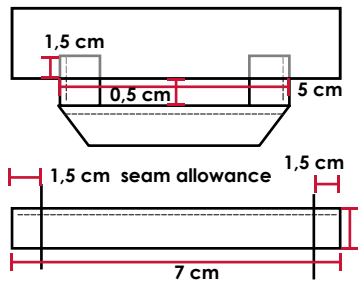

Neck strap width

FIG.107

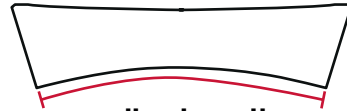

**collar length
along neck seam**

Measure collar along
neck or collar stand seam

FIG.108



**collar length
along outer edge**

Measure collar along
outer edge from point to point

FIG.109

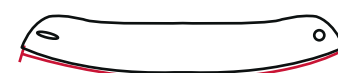

**collar stand along
neck seam**

Measure collar stand along
neck seam from edge to edge

FIG.110

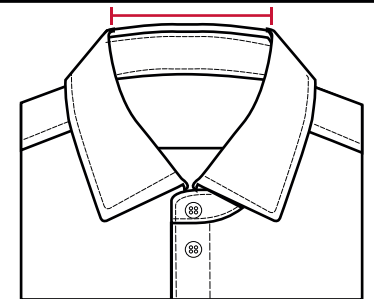

**Neck width at collar
top straight**

FIG.111

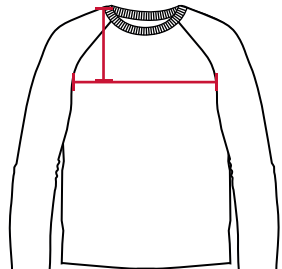

Front width (straight)

Measure across chest straight from
armhole seam to armhole seam

FIG.112

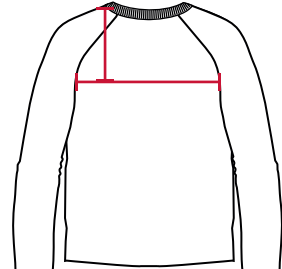

Back width (straight)

Measure across back straight from
armhole seam to armhole seam

FIG.113

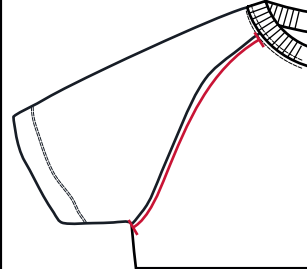

Raglan armhole curve

Measure raglan armhole along curve
from side seam or neck edge.
Both front and back

FIG.114

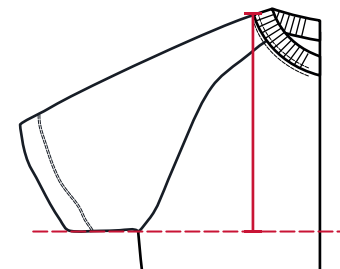

Raglan armhole straight

Measure high point shoulder
vertical to armhole

FIG.115

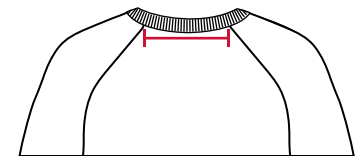

**Raglan distance
between seams at neck
back**

Measure straight from one seam
to the other at neckline back

FIG.116

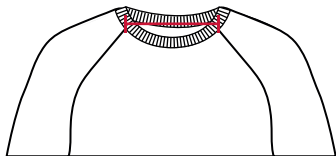

**Raglan distance
between seams at neck
front**

Measure straight from one seam
to the other at neckline front

FIG.36 B

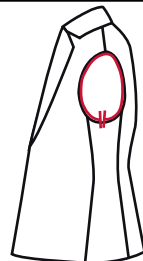

Jacket/Blazer armhole

Measure the armhole all around by
pulling the sleeve inside, for a more
accurate measurement.

FIG.117

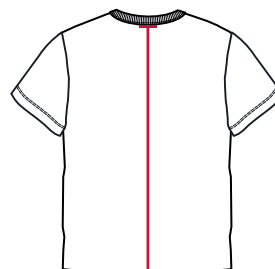

Back length

Measure from collar seam/base
to bottom.

FIG.118

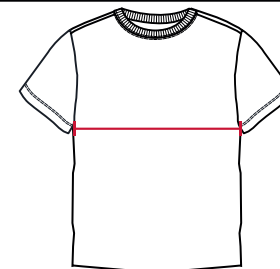

Chest width

Measure from armhole to armhole at
the narrowest point across the bust
point

FIG.119

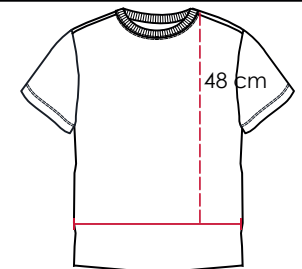

Waist width

Measure 48 cm down from HPS

TMI & CONSTRUCTION

FIG.120	FIG.121	FIG.122	FIG.123	FIG.124
FIG.125	FIG.126	FIG.127	FIG.128	FIG.129
FIG.130	FIG.131	FIG.132	FIG.133	FIG.134